

IP65 Stainless R Series Panel PC

Intel® Core™ Whiskey Lake i5-8265U 1.6GHz

15"/ 17"/ 19"/ 21.5"/ 23.8"

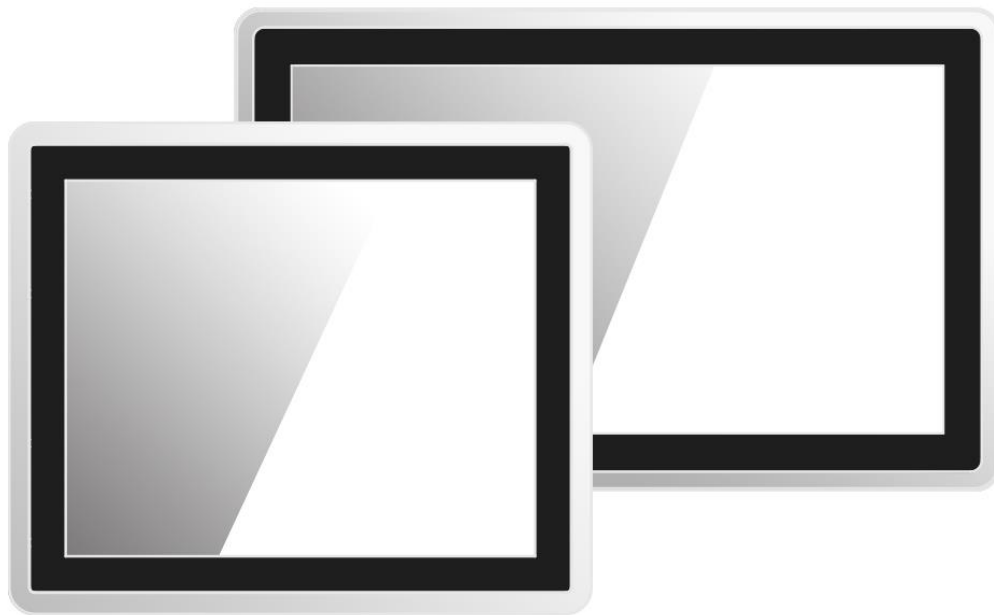

Model No. R15IW3S-SPC3-R
R17IW3S-SPM1-R
R19IW3S-SPM1-R
W22IW3S-SPA3-R
W24IW3S-SPA2-R

User Manual

Contents

Preface	3
About This User Manual	8
Chapter 1: Introduction	9
1.1 Product Features.....	9
1.2 Package Content.....	10
1.3 Connector Placement.....	11
1.4 Physical Buttons and LED Indicators	12
1.5 Schematics and Dimensions	13
1.5.1 Dimensions 15".....	13
1.5.2 Dimensions 17".....	13
1.5.3 Dimensions 19".....	14
1.5.4 Dimensions 21.5".....	14
1.5.5 Dimensions 23.8".....	15
Chapter 2: Getting Started	16
2.1 Powering On	16
2.1.1 AC Adapter Components.....	16
2.1.2 Power Considerations.....	17
2.1.3 Power Consumption	17
2.1.4 Connecting the Power	17
2.2 Connector Pin Assignments	18
2.2.1 Power Cable	18
2.2.2 Serial Cable.....	18
2.2.3 Ethernet Cable.....	19
2.2.4 USB 2.0 Cable.....	19
2.3 Turning On and Off.....	20
Chapter 3: Operating the Device	21
3.1 Operating System.....	21
3.2 Multi-Touch	21
3.3 How to Enable Watchdog.....	25
Chapter 4: Insyde H20 BIOS Setup	26
4.1 When and How to Use BIOS Setup.....	26
4.2 BIOS Functions	27
4.2.1 Main Menu	27
4.2.2 Advanced	28
4.2.3 Boot	40

4.2.4 Security	43
4.2.5 Power	44
4.2.6 Exit	44
4.3 Using Recovery Wizard to Restore Computer	45
Chapter 5: Driver Installation	46
5.1 Installing Chipset Driver	46
5.2 Graphic Driver	48
5.3 Management Engine (ME)	52
5.4 Audio Driver	54
5.5 Ethernet Driver	55
5.6 Watchdog Driver.....	58
5.7 Digital IO Driver	61
Chapter 6: Mounting	63
6.1 Cable Mounting Considerations	63
6.2 Safety Precautions	63
6.3 Mounting Guide	64
6.3.1 VESA Mount	64
6.3.2 Yoke Mount	64
Chapter 7: Technical Support	65
7.1 Software Developer Support	65
7.2 Problem Report Form	66
Appendix A: Product Specifications	67
Appendix B: Order Information	68

Preface

Copyright Notice

No part of this document may be reproduced, copied, translated, or transmitted in any form or by any means, electronic or mechanical, for any purpose, without the prior written permission of the original manufacturer.

Trademark Acknowledgement

Brand and product names are trademarks or registered trademarks of their respective owners.

Disclaimer

Winmate Inc. reserve the right to make changes, without notice, to any product, including circuits and/or software described or contained in this manual in order to improve design and/or performance. We assume no responsibility or liability for the use of the described product(s) conveys no license or title under any patent, copyright, or masks work rights to these products, and make no representations or warranties that these products are free from patent, copyright, or mask work right infringement, unless otherwise specified. Applications that are described in this manual are for illustration purposes only. We make no representation or guarantee that such application will be suitable for the specified use without further testing or modification.

Warranty

Winmate Inc. warranty guarantees that each of its products will be free from material and workmanship defects for a period of one year from the invoice date. If the customer discovers a defect, we will, at his/her option, repair or replace the defective product at no charge to the customer, provide it is returned during the warranty period of one year, with transportation charges prepaid. The returned product must be properly packaged in its original packaging to obtain warranty service. If the serial number and the product shipping data differ by over 30 days, the in-warranty service will be made according to the shipping date. In the serial numbers the third and fourth two digits give the year of manufacture, and the fifth digit means the month (e. g., with A for October, B for November and C for December).

For example, the serial number 1W20Axxxxxxx means October of year 2020.

Customer Service

We provide a service guide for any problem by the following steps: First, visit the website of our distributor to find the update information about the product. Second, contact with your distributor, sales representative, or our customer service center for technical support if you need additional assistance.

You may need the following information ready before you call:

- Product serial number
- Software (OS, version, application software, etc.)
- Description of complete problem
- The exact wording of any error messages

In addition, free technical support is available from our engineers every business day. We are always ready to give advice on application requirements or specific information on the installation and operation of any of our products.

Advisory Conventions

Four types of advisories are used throughout the user manual to provide helpful information or to alert you to the potential for hardware damage or personal injury. These are Notes, Important, Cautions, and Warnings. The following is an example of each type of advisory.



NOTE:

A note is used to emphasize helpful information



IMPORTANT:

An important note indicates information that is important for you to know.



CAUTION/ ATTENTION

A Caution alert indicates potential damage to hardware and explains how to avoid the potential problem.

Une alerte d'attention indique un dommage possible à l'équipement et explique comment éviter le problème potentiel.



WARNING! / AVERTISSEMENT!

An Electrical Shock Warning indicates the potential harm from electrical hazards and how to avoid the potential problem.

Un Avertissement de Choc Électrique indique le potentiel de chocs sur des emplacements électriques et comment éviter ces problèmes.



ALTERNATING CURRENT / MISE À LE TERRE!

The Protective Conductor Terminal (Earth Ground) symbol indicates the potential risk of serious electrical shock due to improper grounding.

Le symbole de Mise à Terre indique le risqué potentiel de choc électrique grave à la terre incorrecte.

Safety Information

WARNING! / AVERTISSEMENT!



Always completely disconnect the power cord from your chassis whenever you work with the hardware. Do not make connections while the power is on. Sensitive electronic components can be damaged by sudden power surges. Only experienced electronics personnel should open the PC chassis.

Toujours débrancher le cordon d'alimentation du chassis lorsque vous travaillez sur celui-ci. Ne pas brancher de connexions lorsque l'alimentation est présente. Des composants électroniques sensibles peuvent être endommagés par des sauts d'alimentation. Seulement du personnel expérimenté devrait ouvrir ces chassis.

CAUTION/ ATTENTION



Always ground yourself to remove any static charge before touching the CPU card. Modern electronic devices are very sensitive to static electric charges. As a safety precaution, use a grounding wrist strap at all times. Place all electronic components in a static-dissipative surface or static-shielded bag when they are not in the chassis.

Toujours vérifier votre mise à la terre afin d'éliminer toute charge statique avant de toucher la carte CPU. Les équipements électroniques modernes sont très sensibles aux décharges d'électricité statique. Toujours utiliser un bracelet de mise à la terre comme précaution. Placer toutes les composantes électroniques sur une surface conçue pour dissiper les charges, ou dans un sac anti-statique lorsqu'elles ne sont pas dans le chassis.

For your safety carefully read all the safety instructions before using the device. Keep this user manual for future reference.

- Always disconnect this equipment from any AC outlet before cleaning. Do not use liquid or spray detergents for cleaning. Use a damp cloth.
- For pluggable equipment, the power outlet must be installed near the equipment and must be easily accessible.
- Keep this equipment away from humidity.
- Put this equipment on a reliable surface during installation. Dropping it or letting it fall could cause damage.
- The openings on the enclosure are for air convection and to protect the equipment from overheating.



CAUTION/ATTENTION

Do not cover the openings!
Ne pas couvrir les ouvertures!

- Before connecting the equipment to the power outlet make sure the voltage of the power source is correct.
- Position the power cord so that people cannot step on it. Do not place anything over the power cord.
- If the equipment is not used for a long time, disconnect it from the power source to avoid damage by transient over-voltage.
- Never pour any liquid into an opening. This could cause fire or electrical shock.
- Never open the equipment. For safety reasons, only qualified service personnel should open

the equipment.

- All cautions and warnings on the equipment should be noted.

***Let service personnel to check the equipment in case any of the following problems appear:**

- The power cord or plug is damaged.
- Liquid has penetrated into the equipment.
- The equipment has been exposed to moisture.
- The equipment does not work well or you cannot get it to work according to the user manual.
- The equipment has been dropped and damaged.
- The equipment has obvious signs of breakage.
- Do not leave this equipment in an uncontrolled environment where the storage temperature is below -20°C (-4°F) or above 60°C (140°F). It may damage the equipment.



CAUTION/ATTENTION

Use the recommended mounting apparatus to avoid risk of injury.
Utiliser l'appareil de fixation recommandé pour éliminer le risque de blessure.



WARNING! / AVERTISSEMENT!

Only use the connection cords that come with the product. When in doubt, please contact the manufacturer.

Utiliser seulement les cordons d'alimentation fournis avec le produit. Si vous doutez de leur provenance, contactez le fabricant.



WARNING! / AVERTISSEMENT!

Always ground yourself against electrostatic damage to the device.

Toujours vérifier votre mise à la terre afin que l'équipement ne se décharge pas sur vous.

- Cover workstations with approved anti-static material. Use a wrist strap connected to a work surface and properly grounded tools and equipment.
- Use anti-static mats, heel straps, or air ionizer for added protection.
- Handle electrostatic-sensitive components, PCB's and assemblies by the case or the edge of the board.
- Avoid contact with pins, leads, or circuitry.
- Turn off power and input signals before inserting and removing connectors or test equipment.
- Keep the work area free of non-conductive materials, such as ordinary plastic assembly aids and Styrofoam.
- Use filed service tools, such as cutters, screwdrivers, and vacuum cleaners that are conductive.
- Always put drivers and PCB's component side on anti-static foam.

General Guideline

It is recommended to reboot the device when some functions are defect or inactive. If it still can't solve the problems, please contact your dealer or agent.

Federal Communications Commission Radio Frequency Interface Statement



This device complies with part 15 FCC rules.

Operation is subject to the following two conditions:

- This device may not cause harmful interference.
- This device must accept any interference received including interference that may cause undesired operation.

This equipment has been tested and found to comply with the limits for a class "B" digital device, pursuant to part 15 of the FCC rules. These limits are designed to provide reasonable protection against harmful interference when the equipment is operated in a commercial environment. This equipment generates, uses, and can radiate radio frequency energy and, if not installed and used in accordance with the instruction manual, may cause harmful interference to radio communications. Operation of this equipment in a residential area is likely to cause harmful interference in which case the user will be required to correct the interference at his own expense.

European Union



This equipment is in conformity with the requirement of the following EU legislations and harmonized standards. Product also complies with the Council directions.

Electromagnetic Compatibility Directive (2014/30/EU)

- EN55024: 2010/ A1: 2015
 - IEC61000-4-2: 2009
 - IEC61000-4-3: 2006+A1: 2007+A2: 2010
 - IEC61000-4-4: 2012
 - IEC61000-4-5: 2014
 - IEC61000-4-6: 2014
 - IEC61000-4-8: 2010
 - IEC61000-4-11: 2004
- EN55032: 2012/AC:2013
- EN61000-3-2:2014
- EN61000-3-3:2013

Low Voltage Directive (2014/35/EU)

- EN 60950-1:2006/A11:2009/A1:2010/A12:2011/ A2:201

About This User Manual

This User Manual provides information about using the Winmate® IP65 Stainless R Series Panel PC with Intel® Core™ Whiskey Lake i5-8265U 1.6GHz processor. This User Manual applies to the IP65 Stainless R Series Panel PC R15IW3S-SPC3-R, R17IW3S-SPM1-R, R19IW3S-SPM1-R, W22IW3S-SPA3-R, W24IW3S-SPA2-R.

The documentation set for the IP65 Stainless R Series Panel PC provides information for specific user needs, and includes:

- **IP65 Stainless R Series Panel PC User Manual**
- **IP65 Stainless R Series Panel PC Quick Start Guide**



NOTE:

Some pictures in this guide are samples and can differ from actual product.

Chapter 1: Introduction

Winmate® IP65 Stainless R Series Panel PC is rugged, industrial-grade panel PC series built to withstand challenging environments, undergoing rigorous testing to ensure safety and top performance. All of the models in the series are sealed to IP65 standard. Stainless housing features anti-corrosion properties making it suitable for food, chemical and pharmaceutical industries. PCAP multi-touch screen supports glove mode and provides even more convenience for the operator.

Winmate® IP65 Stainless R Series Panel PC goes beyond that of the standard industrial panel computers with elegant, edge-to-edge design, rugged construction, powerful performance, and flexible mounting options.

1.1 Product Features



Winmate® IP65 Stainless R Series Panel PC features:

- 8th Generation (Whiskey Lake) Intel® Core™ i5-8265U 1.6GHz (turbo to 3.9GHz)
- Round corner design
- A true flat, easy-to-clean front surface with an edge-to-edge design
- Sealed to IP65 for protection against water and dust
- Support Glove / Rain mode
- SUS 316 / AISI 316 stainless steel housing
- Various mounting solutions
- Optical bonding (optional)

1.2 Package Content

Carefully remove the box and unpack your Panel PC. Please check if all the items listed below are inside your package. If any of these items are missing or damaged contact us immediately.

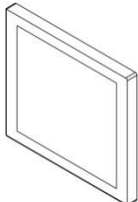
Standard factory shipment list

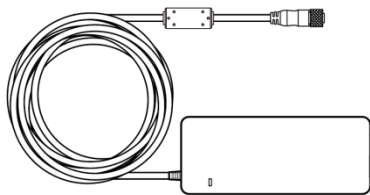
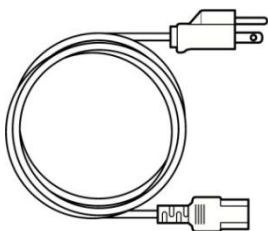
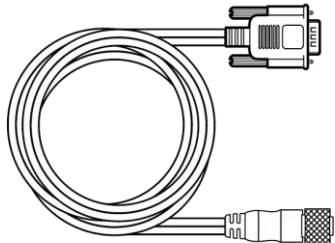
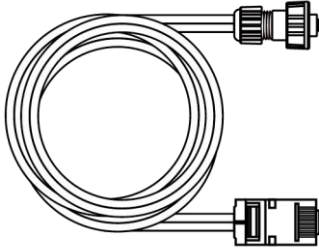
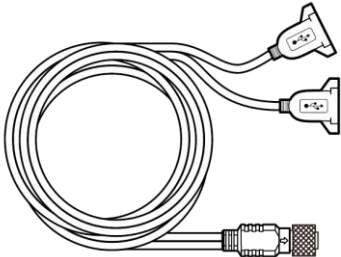
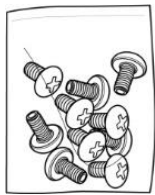
		
Panel PC	Quick Start Guide (Hardcopy)	Driver CD & User Manual
Varies by product specifications	Part No. 915211101091	Part No. 915211101090
		
AC Adapter	Power Cable*	Serial Cable
Part No. 50W: 90PO12050006 Part No. 84W: 90PO12084000	Varies by country	Part No. 94G0123090Q0
		
Ethernet Cable	USB Cable	VESA Screws
Part No. 94I0080080KF	Part No. 9480128080K0	Part No.913511101101

1.3 Connector Placement

IP65 Stainless R Series Panel PC has IP65 type connectors with protection cap.

For cable specifications refer to the [2.2 Connector Pin Assignments](#) of this user manual.

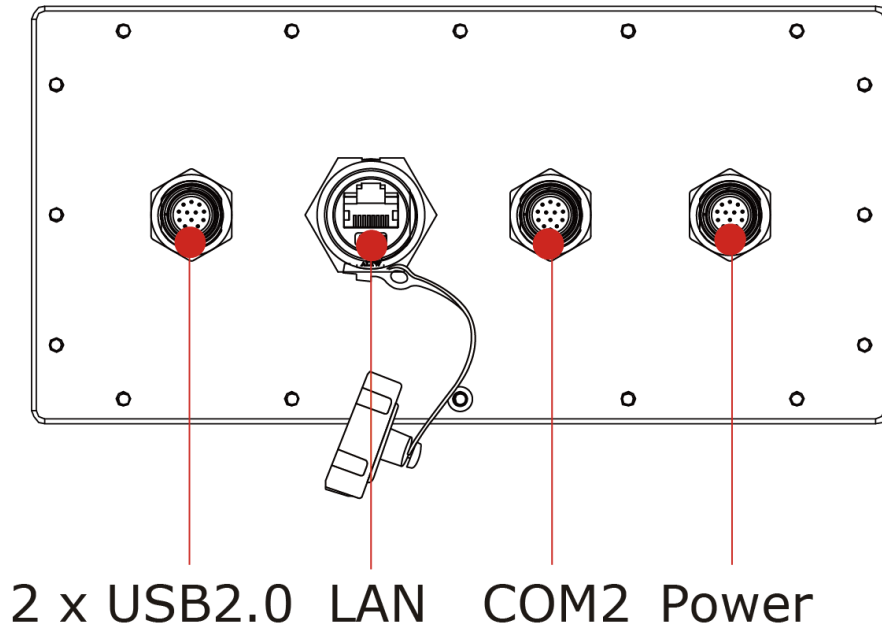



1.4 Physical Buttons and LED Indicators

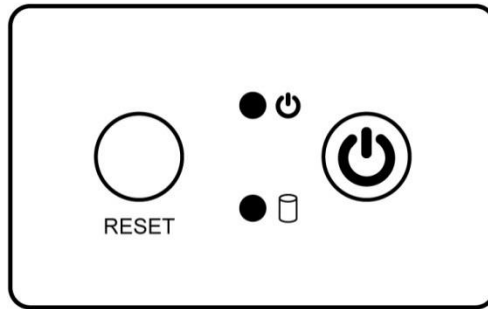

Physical buttons and LED indicators located on the rear side of the Panel PC.



Physical Buttons

Icon	Button	Description
	Reset	Press to reset the system
	Power On/ Off	Press to power on or power off the device

LED Indicators

LED Type	Status	Description
	On	Power is on
	Off	Power is off
	Blinking	Storage activity (Data is being read or written)
	Off	System is idle

1.5 Schematics and Dimensions

This section contains mechanical drawing of the panel PC. Notice that this is a simplified drawing and some components are not marked in detail.

1.5.1 Dimensions 15"

Unit: mm

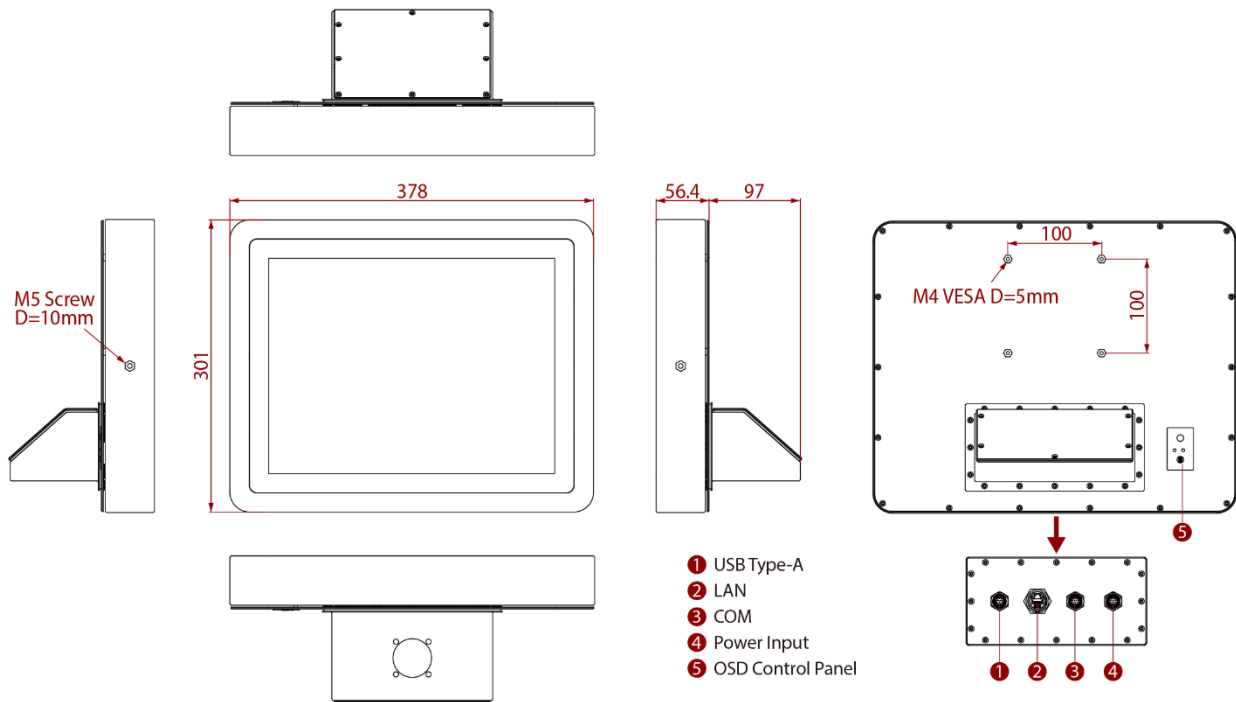

1.5.2 Dimensions 17"

Unit: mm

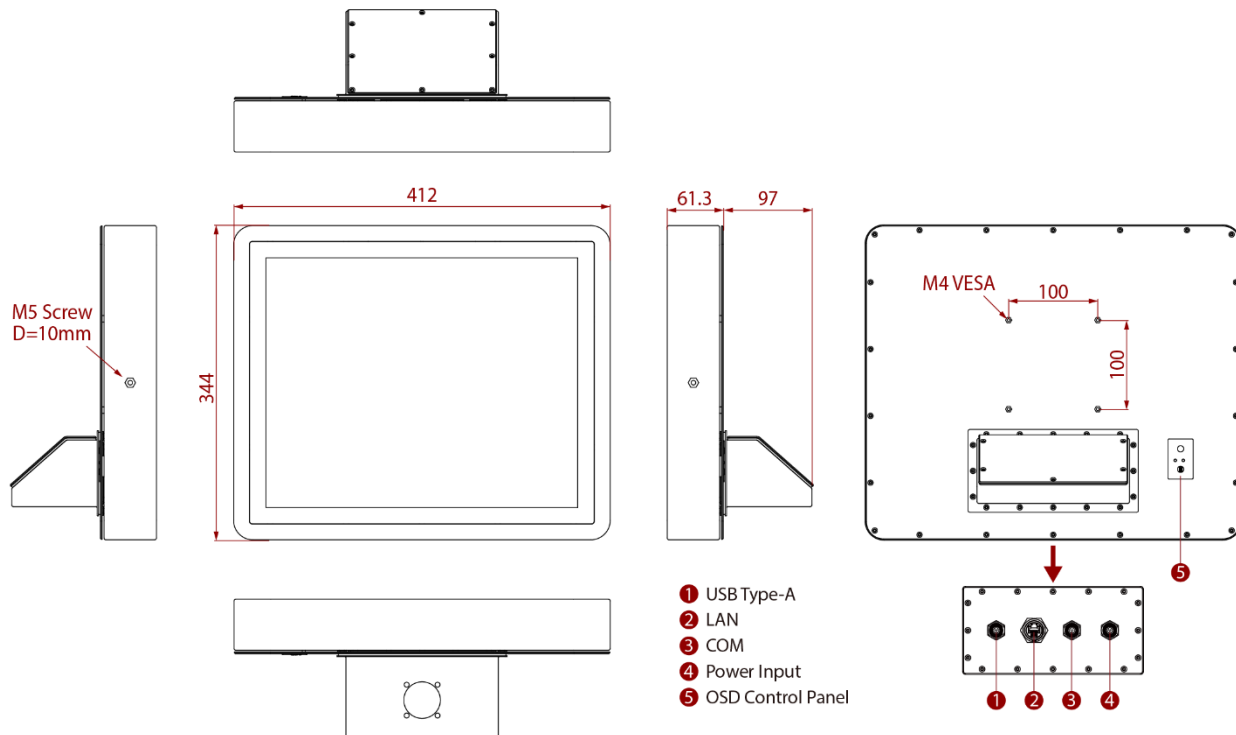

1.5.3 Dimensions 19"

Unit: mm

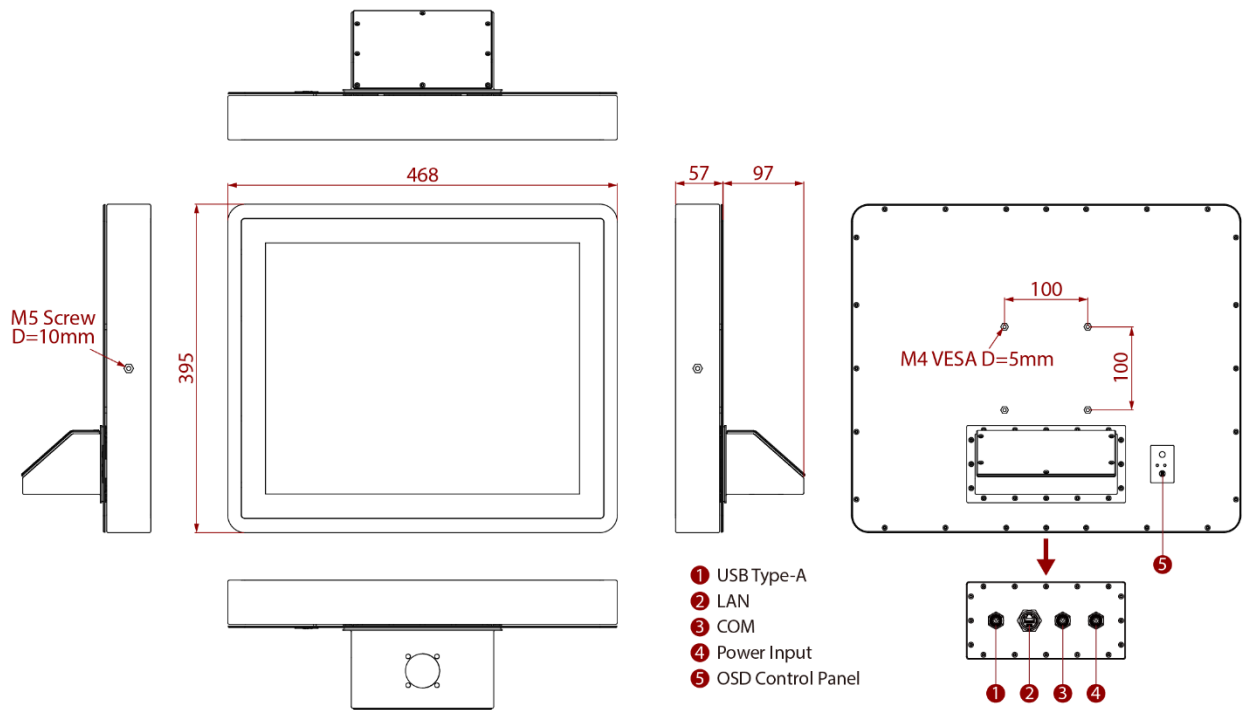

1.5.4 Dimensions 21.5"

Unit: mm

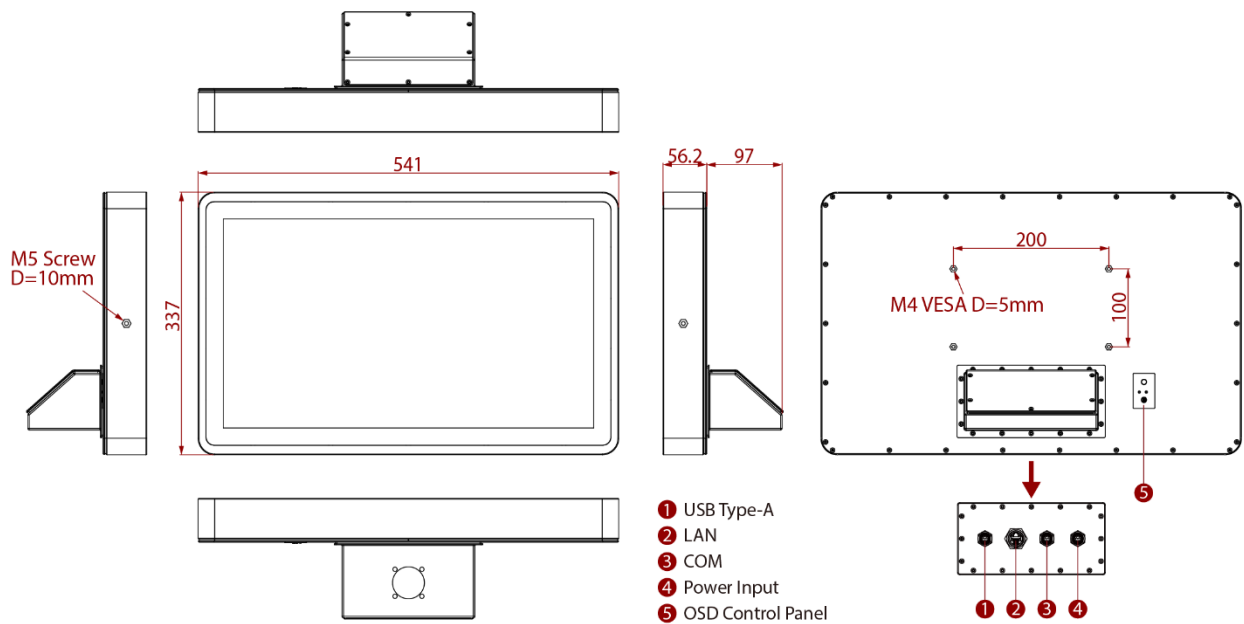

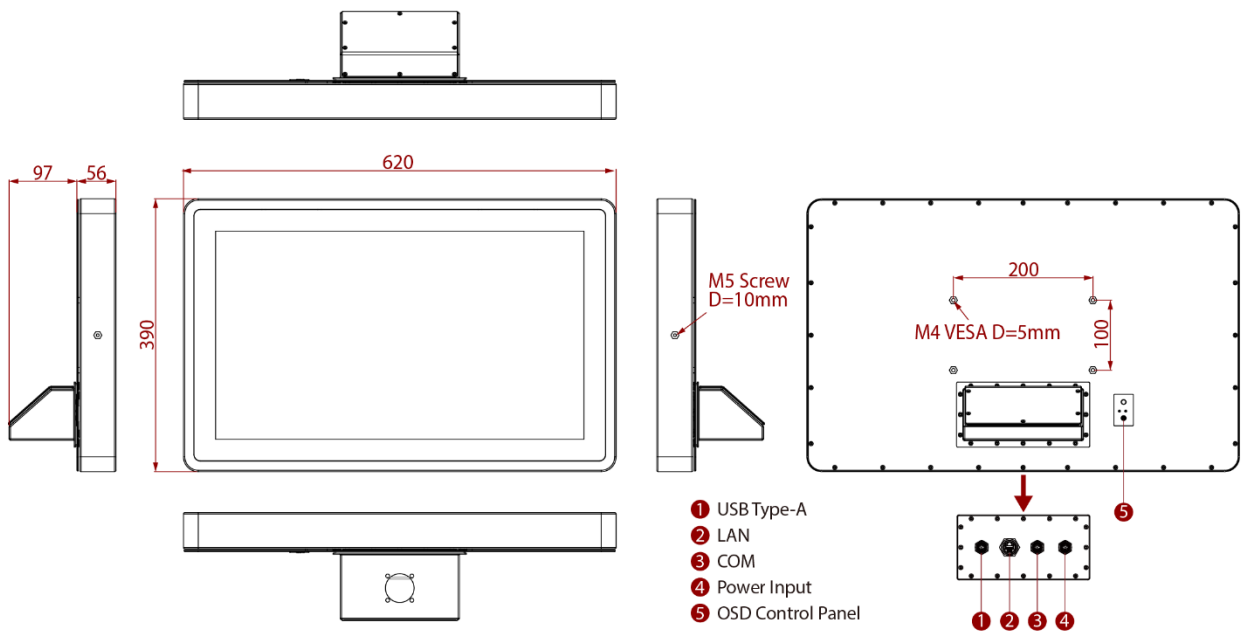
1.5.5 Dimensions 23.8"*Unit: mm*

Chapter 2: Getting Started

This chapter provides information on how to connect the panel PC to the source of power, connector pinouts and the guideline to turn on/off the Panel PC.

2.1 Powering On

2.1.1 AC Adapter Components

AC Adapter supplied with the power cord.

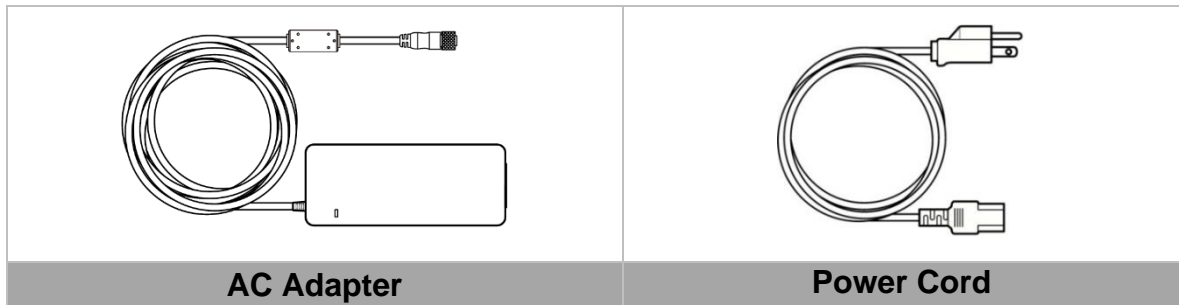

AC Adapter specifications vary by panel size.

Size	15"	17"	19"	21.5"	23.8"
AC Adapter	12V/ 80W	12V/ 80W	12V/ 80W	12V/ 80W	12V/ 80W

Safety Precautions:

- Do not use the adapter in a high moisture environment
- Never touch the adapter with wet hands or foot
- Allow adequate ventilation around adapter while using
- Do not cover the adapter with paper or other objects that will reduce cooling
- Do not use the adapter while it is inside a carrying case
- Do not use the adapter if the cord is damaged
- There are NO serviceable parts inside
- Replace the unit if it is damaged or exposed to excess moisture

While using the AC Adapter always:

- Plug-in the power cord to easy accessible AC outlet
- Plug-in the AC adapter to a grounded outlet



ALTERNATING CURRENT / MISE À LE TERRE!

This product must be grounded. Use only a grounded AC outlet. Install the additional PE ground wire if the local installation regulations require it.

**If you do not use a grounded outlet while using the device, you may notice an electrical tingling sensation when the palms of your hands touch the device.*

Ce produit doit être mis à la terre. Utiliser seulement un cordon d'alimentation avec mise à la terre. Si les règlements locaux le requiert, installer des câbles de mise à la terre supplémentaires.

**Si vous n'utilisez pas une prise d'alimentation avec mise à la terre, vous pourriez remarquer une sensation de picotement électrique quand la paume de vos mains touche à l'appareil.*

2.1.2 Power Considerations

The Panel PC operates on external DC power. Use the AC adapter included in the package.



CAUTION/ATTENTION

Use only the AC adapter included in your package. Using other AC adapters may damage the device.

Utiliser seulement le convertisseur AC inclus avec votre appareil. Utiliser d'autres convertisseurs pourraient endommager l'appareil.

2.1.3 Power Consumption

The table below shows power consumption and AC adapter for the Stainless Panel PC.

Size	15"	17"	19"	21.5"	23.8"
Power Consumption*	38W (typ.)	43W (typ.)	45W (typ.)	56W (typ.)	56W (typ.)

*With maximum backlight and high CPU load.

2.1.4 Connecting the Power

Cable Mounting Steps:

1. Connect the AC adapter to the DC-in jack connector located on the back side of the Panel PC.
2. Connect the power cord to AC adapter.
3. Plug the power cord to the AC outlet and the device will turn on automatically.

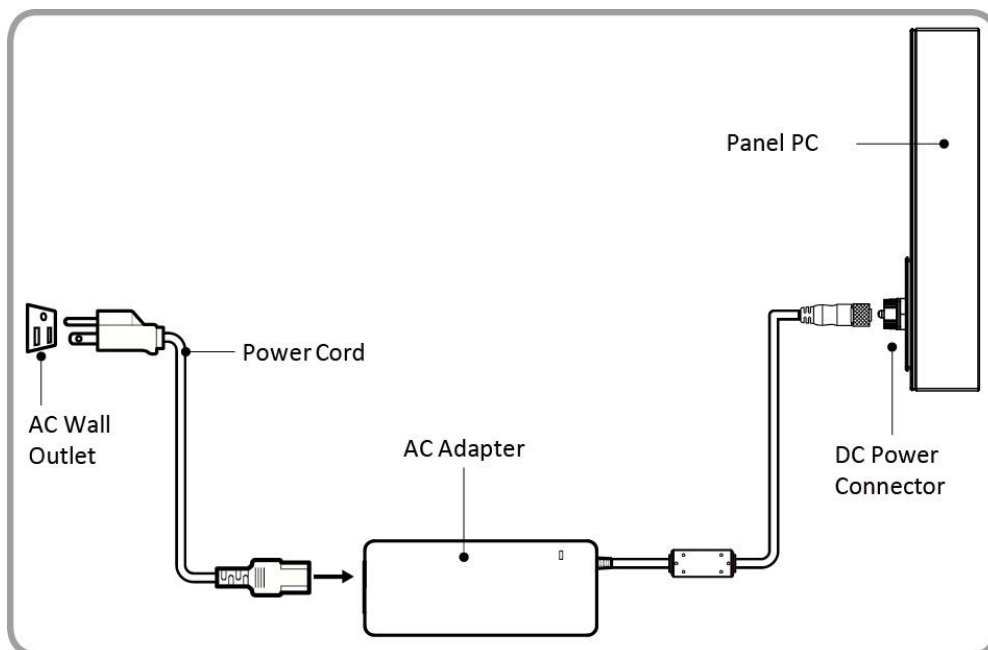

Note:



Power cords vary in appearance by region and country.

2.2 Connector Pin Assignments

This Panel PC is equipped with four connectors which are IP65 level and fool-proofing design. Use only the cables that are included in the package. The pin assignments of the cables are as follows.

2.2.1 Power Cable

The Stainless R Series Panel PC has IP65 connector. Use power cable to connect Panel PC to the source of power.

Stainless R Series Panel PC support 12V DC power input.

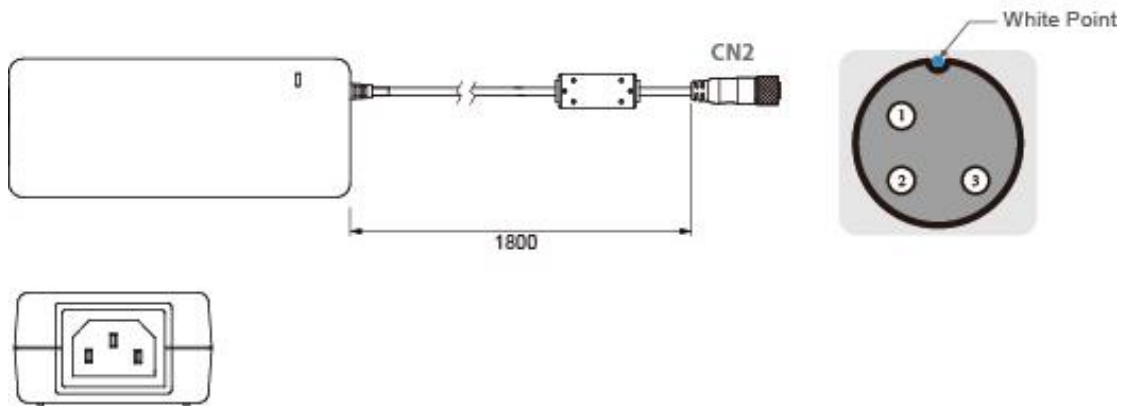

Pin No.	Symbols	Color		Pin No.	Symbols	Color
CN1-1	VIN -	NO ASSIGN	↔	CN2-1	VCC+	Flow Adapter
CN1-2	VIN -	NO ASSIGN	↔	CN2-2	GND	Flow Adapter
CN1-3	VIN -	NO ASSIGN	↔	CN2-3	VCC -	Flow Adapter

2.2.2 Serial Cable

The Stainless R Series Panel PC has IP65 serial port connector. Use serial cable to connect serial interfaces.

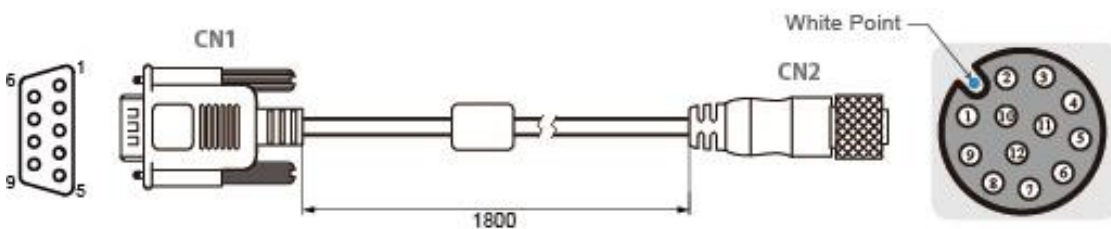

Pin No.	Symbols	Color		Pin No.	Symbols	Color
CN1-1	DCD-CON2	Green	↔	CN2-1	DCD-CON2	Green
CN1-6	DSR-CON2	Brown	↔	CN2-2	DSR-CON2	Brown
CN1-2	RXD-CON2	Red	↔	CN2-3	RXD-CON2	Red
CN1-7	RTS-CON2	Orange	↔	CN2-4	RTS-CON2	Orange
CN1-3	TXD-CON2	Blue	↔	CN2-5	TXD-CON2	Blue
CN1-8	CTS-CON2	White	↔	CN2-6	CTS-CON2	White
CN1-4	DTR-CON2	Purple	↔	CN2-7	DTR-CON2	Purple
CN1-9	RI-CON2	Yellow	↔	CN2-8	RI-CON2	Yellow
CN1-5	GND-CON2	Black	↔	CN2-9	GND-CON2	Black

2.2.3 Ethernet Cable

The Stainless R Series Panel PC has IP65 Ethernet connector. Use Ethernet cable to connect the Panel PC to the Internet.

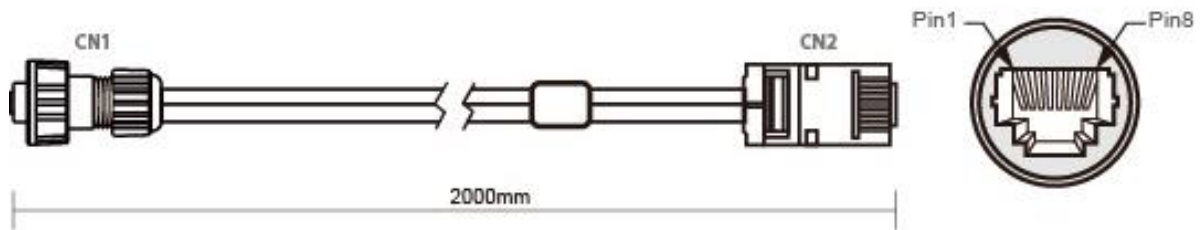

Plug	Wire Color	Conn.	
1	Orange / White	1	Twist
2	Orange	2	
3	Green / White	3	Twist
4	Blue	4	
5	Blue / White	5	
6	Green	6	Twist
7	Brown / White	7	
8	Brown	8	Twist

2.2.4 USB 2.0 Cable

Stainless R Series Panel PC has one Full IP65 USB2.0 connector. Use USB2.0 cable to connect external devices such as mouse or keyboard to the Panel PC.

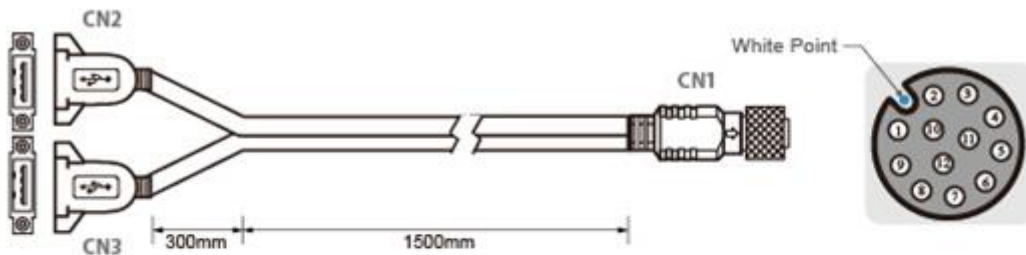

Pin No.	Symbols	Color		Pin No.	Symbols	Color	
CN1-2	VCC	RED	↔	CN2-1	VCC	RED	twisted pair
CN1-3	D-	WHITE	↔	CN2-2	D-	WHITE	
CN1-4	D+	GREEN	↔	CN2-3	D+	GREEN	
CN1-5	GND	BLACK	↔	CN2-4	GND	BLACK	
CN1-6	VCC	RED	↔	CN3-1	VCC	RED	twisted pair
CN1-7	D-	WHITE	↔	CN3-2	D-	WHITE	
CN1-8	D+	GREEN	↔	CN3-3	D+	GREEN	
CN1-9	GND	BLACK	↔	CN3-4	GND	BLACK	
CN1-1	GND	Braid	↔	Braid connect to the housing			

2.3 Turning On and Off

The unit is configured to **Power ON** when is connected to the power source (refer to [2.1 Powering On](#) section of this user manual for more details on how to power on the HMI device).

You can **Turn OFF** the Panel PC with the Windows power settings.
To shut down the device:

1. Tap **Start**  **>Shut down.**
2. Wait for your Panel PC to completely turn off before disconnecting the power cord (if necessary).

Chapter 3: Operating the Device

In this chapter you will find instructions on how to operate the Panel PC with Hot Tab.

3.1 Operating System

Stainless R Series Panel PC support several versions of Windows OS: Windows 10 IoT Enterprise, Windows Embedded 8.1 Industry Pro, Windows Embedded 8 Standard, Windows 7 Pro for Embedded Systems, and Windows Embedded Standard 7 – WS7P.









IMPORTANT:

The device is shipped with the OS System according to your order. Contact us if you have any questions regarding OS settings.

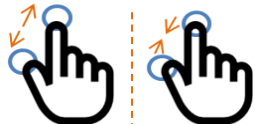
3.2 Multi-Touch

The touchpad supports the core gestures for Windows.

Gesture	Windows Usage	Gesture Action	Action
Tap/ Double-tap	Click / Double-click	Click or double-click	
Panning with Inertia	Scrolling	Drag one or two fingers up and down	
Selection/Drag (left to right with one finger)	Mouse-drag/ Selection	Drag one finger left/right	
Zoom	Zoom (default to CTRL key + scroll wheel)	Move two fingers apart/ toward each other	
Rotate	No system default unless handled by Application (using WM_Gesture API)	Move two fingers in opposite directions or Use one finger to pivot around another	
Press and Hold	Right-click	Press, wait for blue- ring animation to complete, then release	
Flicks	Default: Pan Up/ Down/ Back, and Forward	Make quick drag gestures in the described direction	

*Reference from Microsoft®

IP65 Stainless Panel PC has three types touch modes pre-installed with Windows OS. Set it through **TouchModeSelect**  on the bottom right corner of the toolbar.

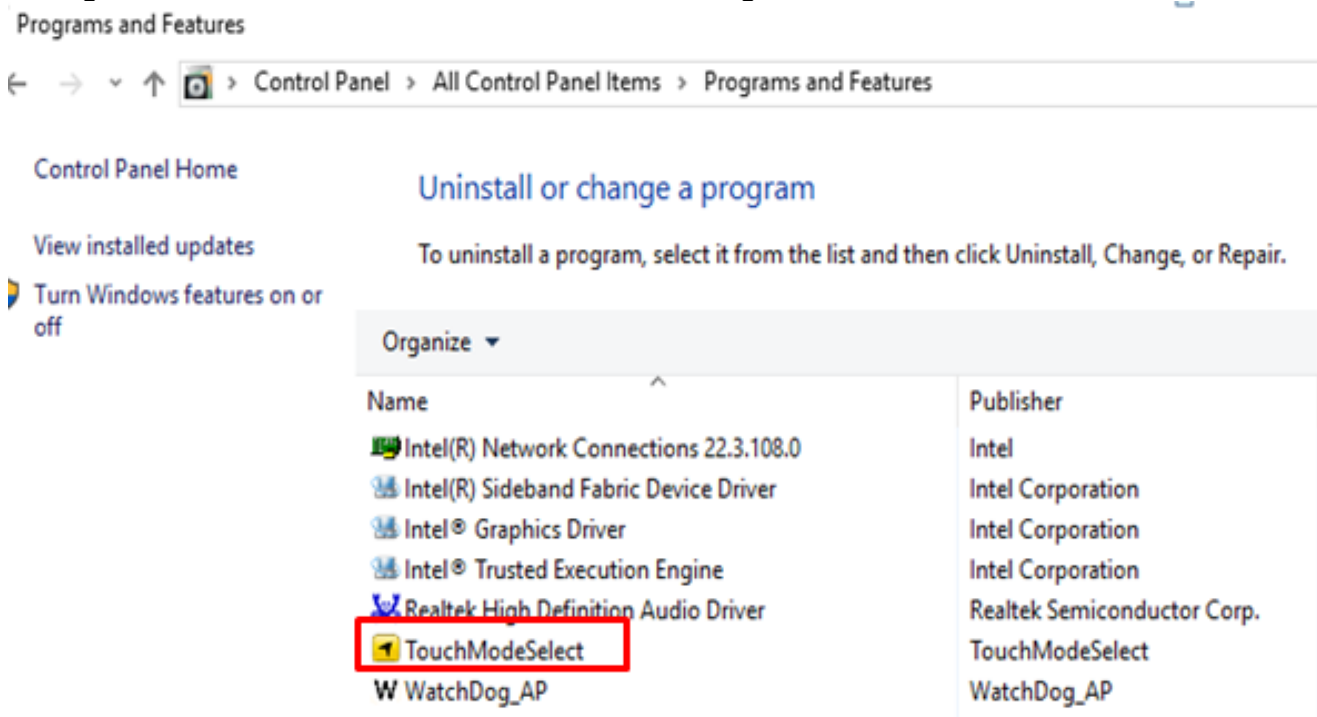

If the OS is not installed, please download the application on our website for switching the touch modes. If you cannot find it, please download it from Winmate Download Center or contact Winmate sales representative.

Follow the instructions below to install the *TouchModeSelect* Utility.

1. Download, install and execute **TouchModeSelect_1.2.3** setup wizard.
2. Click **Next** to continue.

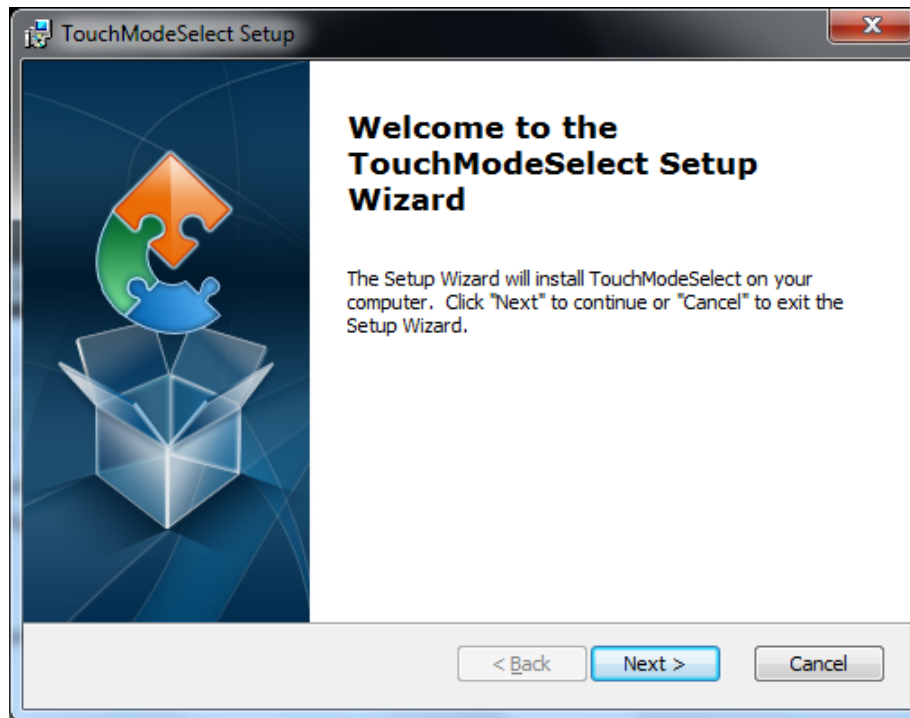

3. Select the installation folder, and click **Next** to continue.

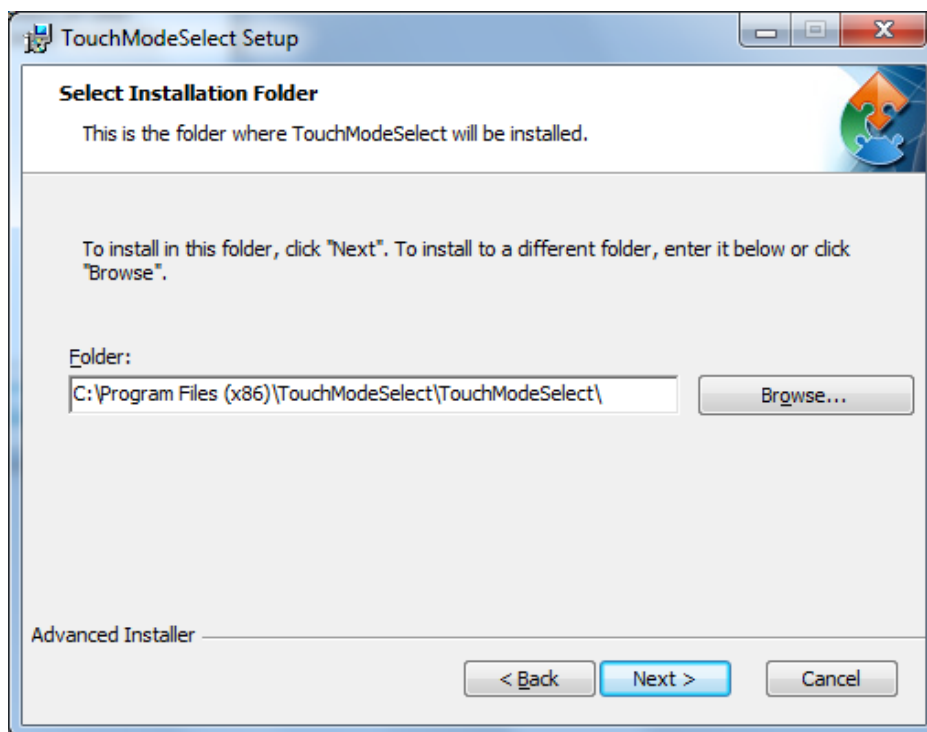

4. The Setup Wizard is ready to begin the **TouchModeSelect** installation. Click **Install** to proceed.

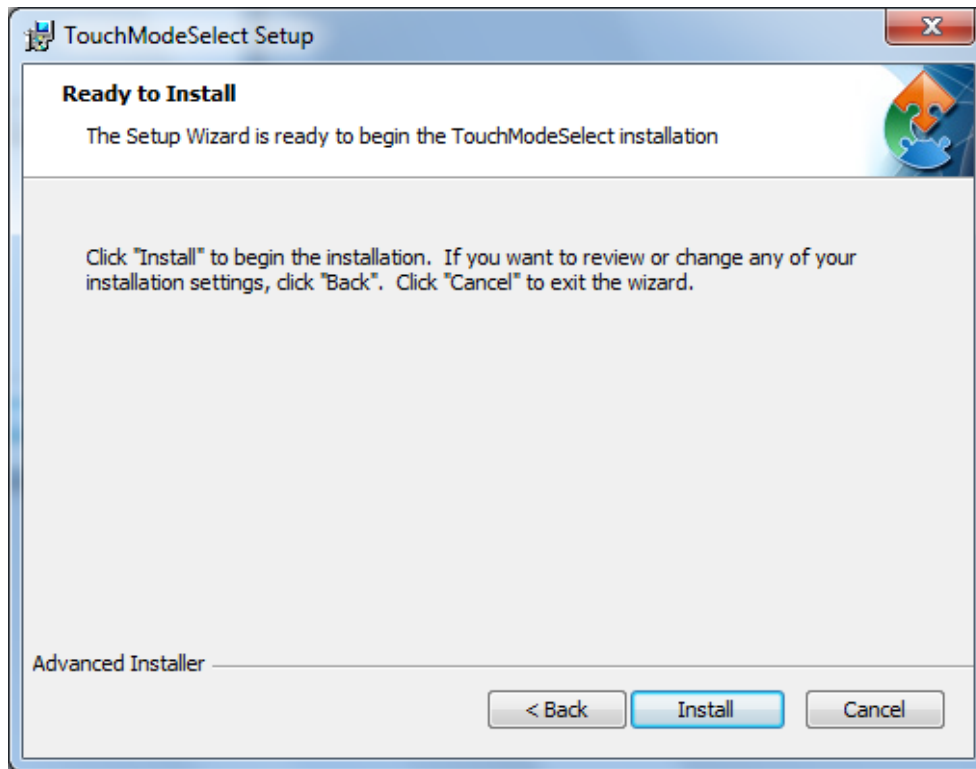

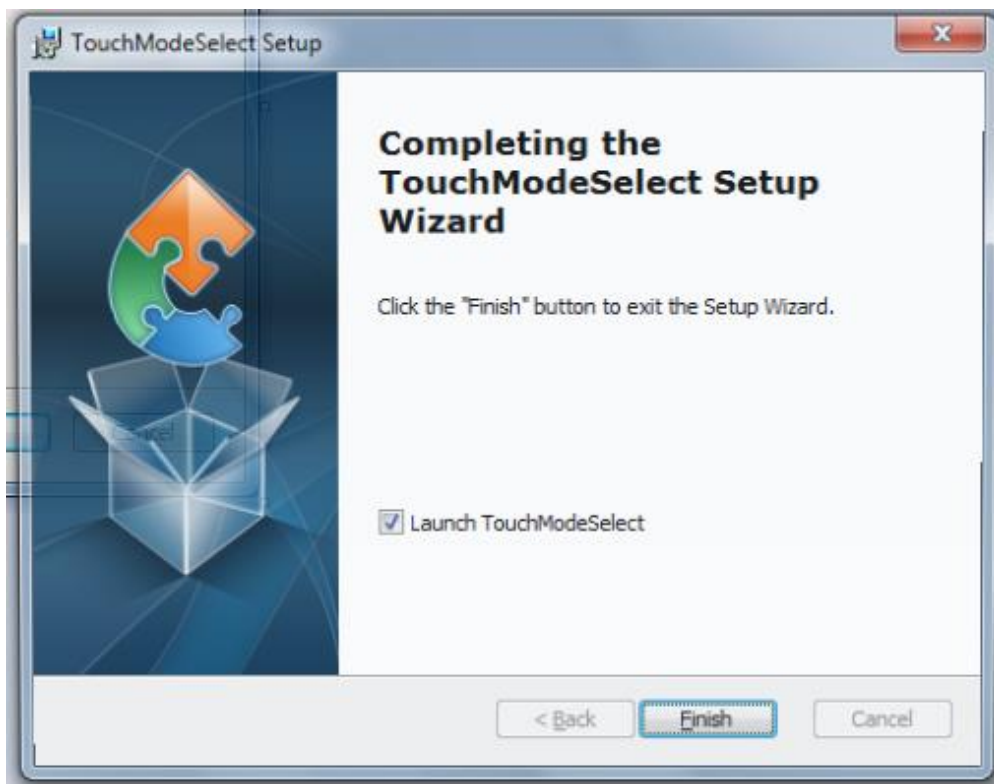

5. When installation is complete, click **Finish** button to exit the Setup Wizard.



3.3 How to Enable Watchdog

To enable Watchdog, you need to download Winmate Watchdog utility. Find more information on Watchdog in “Watchdog Guide” that you can download from Winmate Download Center or File Share. Refer to the [Chapter 7: Technical Support](#) for more details.

To enable watchdog in Watchdog AP follow the instructions below:

1. On the right bottom side of the desktop screen, click  **triangle button** to show hidden icons.
2. Click  **W** icon to open Watchdog utility.

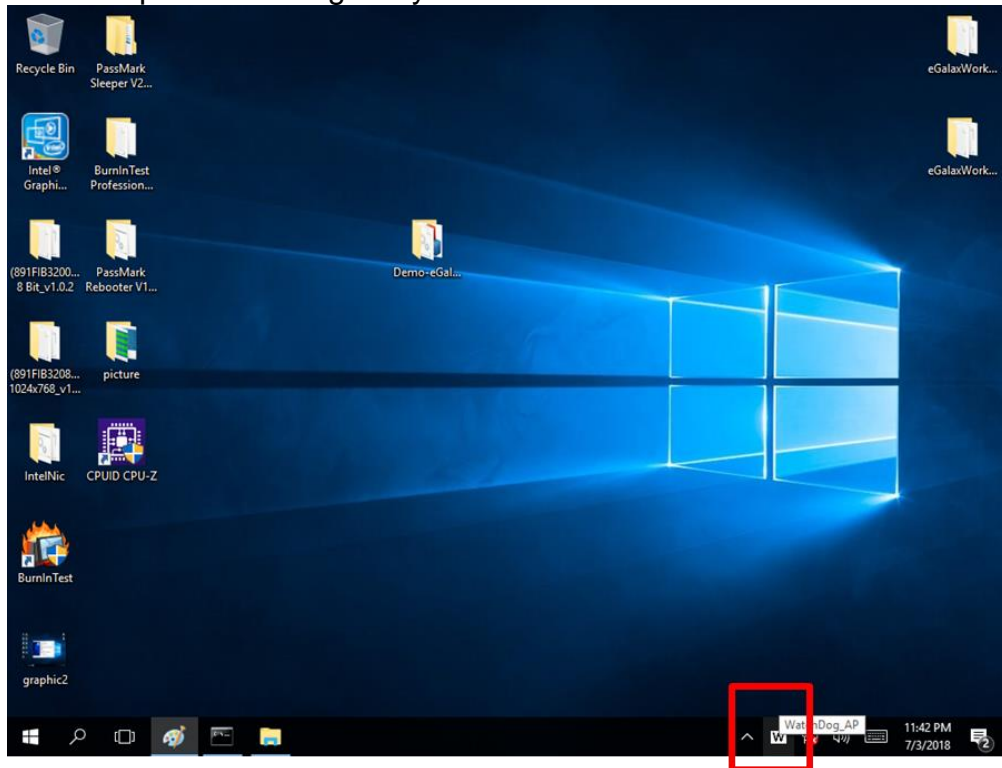

3. In Watchdog utility window set countdown time and periodically feed time, or disable watchdog.

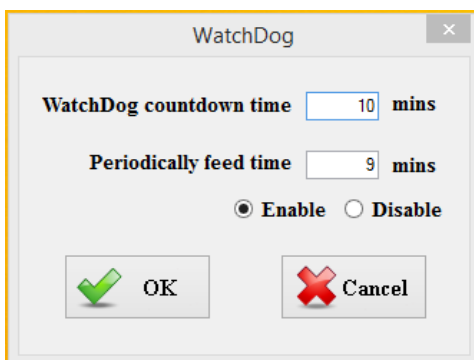

Example:

Every 10 min watchdog will monitor the system, in case any error occurs the system will restart automatically when the countdown time reaches 0.
Every 9 min watchdog timer will be reset to 10 min.

Settings	Description
Watchdog Countdown Time	The system automaticity restarts when this countdown time reaches zero. <i>Default: 10 min</i>
Periodically Feed Time	To set a cycle time to automatically reset watchdog timer. <i>Default: 9 min</i>
Enable / Disable	Enable or disable watchdog. <i>Default: Enable</i>

Chapter 4: Insyde H20 BIOS Setup

BIOS Setup Utility is a program for configuration basic Input / Output system settings of the computer for optimum use. This chapter provides information on how to use BIOS setup, its functions and menu.

4.1 When and How to Use BIOS Setup

To enter the BIOS setup, you need to connect an external USB keyboard, external monitor and press Del key when the prompt appears on the screen during start up. The prompt screen shows only few seconds so need press **Del** key quickly.



IMPORTANT:

Updated BIOS version may be published after the manual released. Check the latest version of BIOS on the website.

You may need to run BIOS setup utility for reasons listed below:

1. Error message on screen indicates to check BIOS setup
2. Restoring the factory default settings.
3. Modifying the specific hardware specifications
4. Necessity to optimize specifications

BIOS Navigation Keys

The following keys are enabled during POST:

Key	Function
Del	Enters the BIOS setup menu.
F7	Display the boot menu. Lists all bootable devices that are connected to the system. With cursor ↑ and cursor ↓ and by pressing <ENTER>, select the device used for the boot.
Pause	Pressing the [Pause] key stops the POST. Press any other key to resume the POST.

The following Keys can be used after entering the BIOS Setup.

Key	Function
F1	Help
F5/ F6	Change Values
F9	Setup Defaults
F10	Save & Exit
Esc	Exit
Enter	Select SubMenu
↑ / ↓	Select Item
← / →	Select Item

For items marked ► press <Enter> for more options.



NOTE:

You can press the F1, F2, F3, F4, -/+, and Esc keys by connecting a USB keyboard to your computer.

4.2 BIOS Functions

4.2.1 Main Menu

The Main menu displays the basic information about your system including BIOS version, processor RC version, system language, time, and date. When you enter BIOS setup, the first menu that appears on the screen is the main menu. It contains the system information including BIOS version, processor RC version, system language, time, and date.

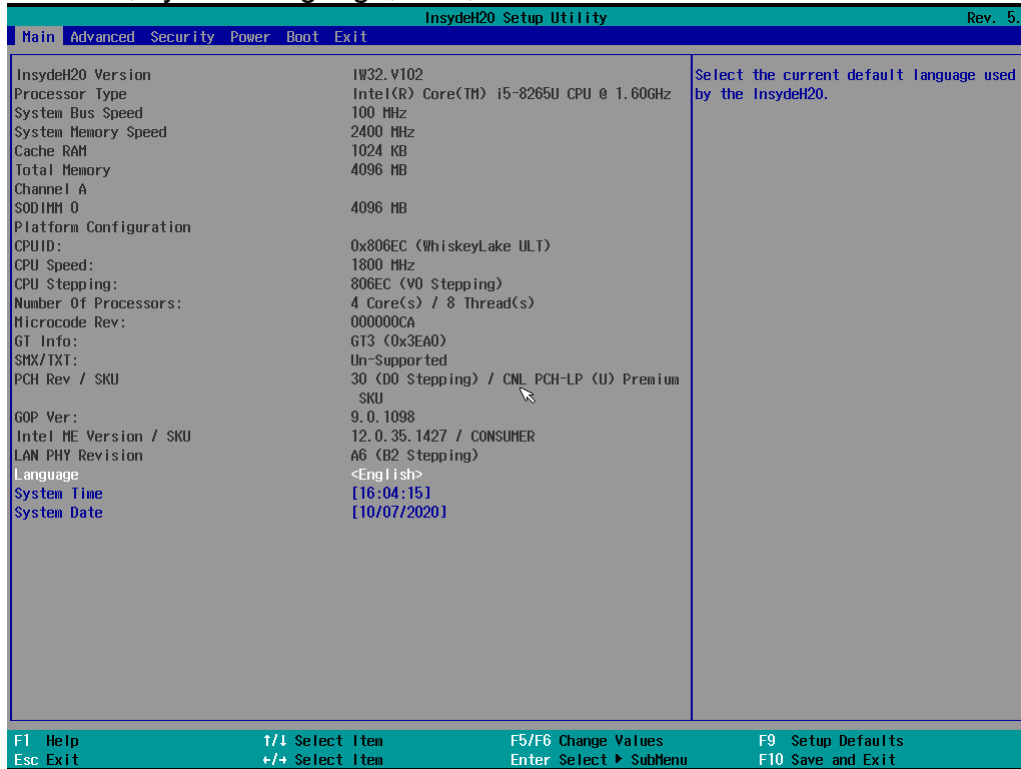

BIOS Setting	Description	Setting Option	Effect
Language	Displays the system language. [English] is set up by default.	Adjustment of the language	Set the language in other language. The language in this device is English.
System Time	This is current time setting. The time is maintained by the battery when the device is turned off.	Date and time changes.	Set the time in the format: [hh/mm/ss]
System Date	This is current date setting.	Date and time changes.	Set the date in the format [mm/dd/yyyy];

4.2.2 Advanced

Select the Advanced Tab from the setup menu to enter the advanced BIOS setup screen. You can select any of the items on the left frame of the screen to go to the sub menu for the item, such as CPU Configuration. You can use the <Arrow> keys enter all advanced BIOS setup options. The advanced BIOS setup menu is shown below. The submenus described on the following pages.



CAUTION

Handle advanced BIOS settings page with caution. Any changes can affect the operation of your computer.

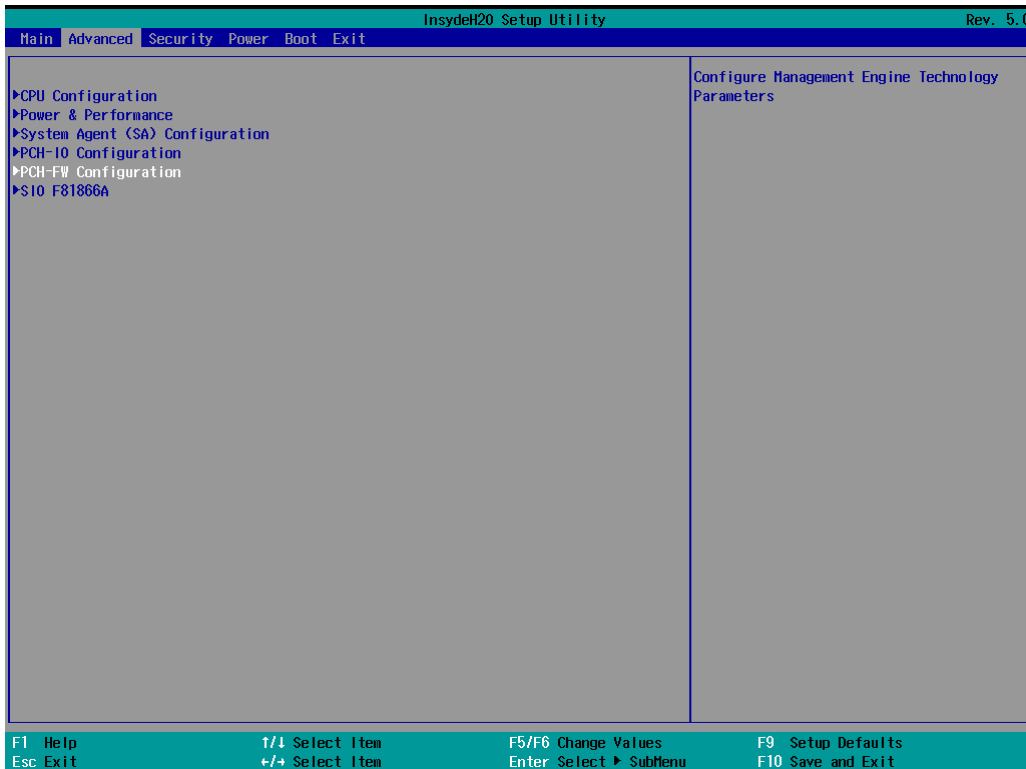

BIOS Setting	Description	Setting Option	Effect
CPU Configuration	Configures Trusted Computing parameters	Enter	Opens submenu
Power & Performance	Configures Power & Performance parameters	Enter	Opens submenu
System Agent Configuration	Configures System Agent Configuration parameters	Enter	Opens submenu
PCH-IO Configuration	Configures PCH-IO parameters	Enter	Opens submenu
PCH-FM Configuration	Configures PCH-FM parameters	Enter	Opens submenu
SIO F81866A	Configures SIO F81866A parameters	Enter	Opens submenu

4.2.2.1 CPU Configuration

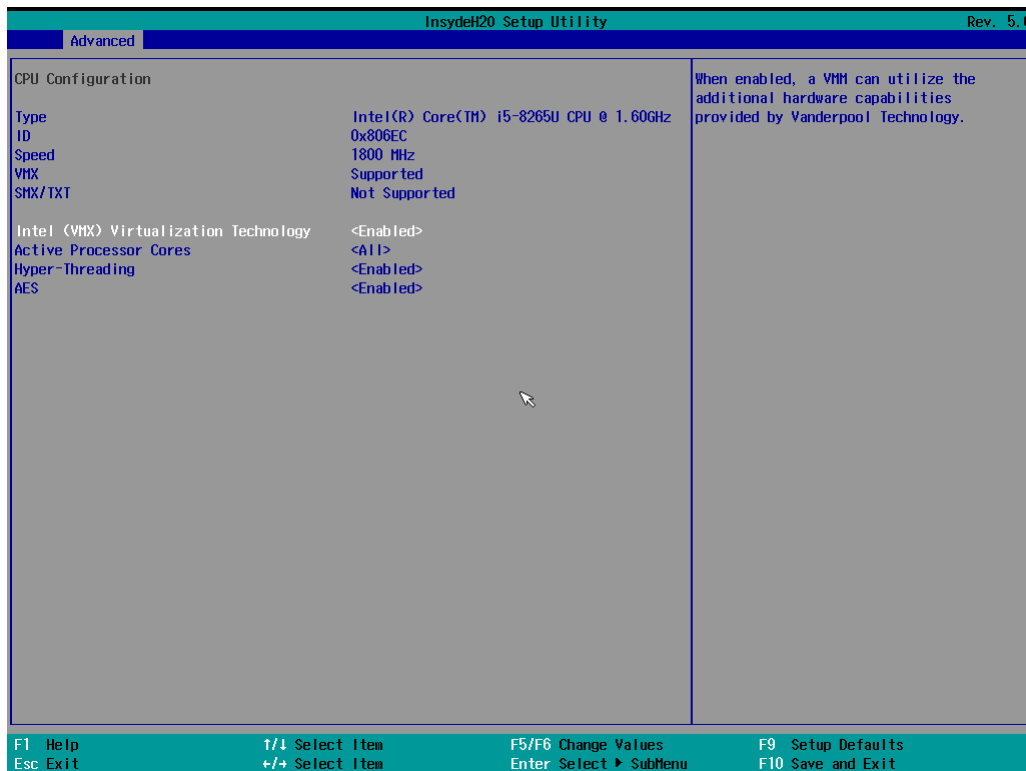

BIOS Setting	Description	Setting Option	Effect
Intel (VMX) Virtualization Technology	Enable or disable Intel Virtualization Technology.	Enable/Disable	When enabled, a VMM can utilize the additional hardware capabilities provided by Vanderpool Technology.
Active Processor Cores	Number of core to enable in each processor package	All / 1 / 2 / 3	Select number of core to enable in each processor package
Hyper Threading	Intel Hyper-Threading Technology allows a single processor to execute two or more separate threads concurrently.	Enable / Disable	Enable or disable Hyper Threading
AES	Enable or disable AES (Advanced Encyption Standard)	Enable/Disable	Enable or disable AES

4.2.2.2 F81886A Configuration

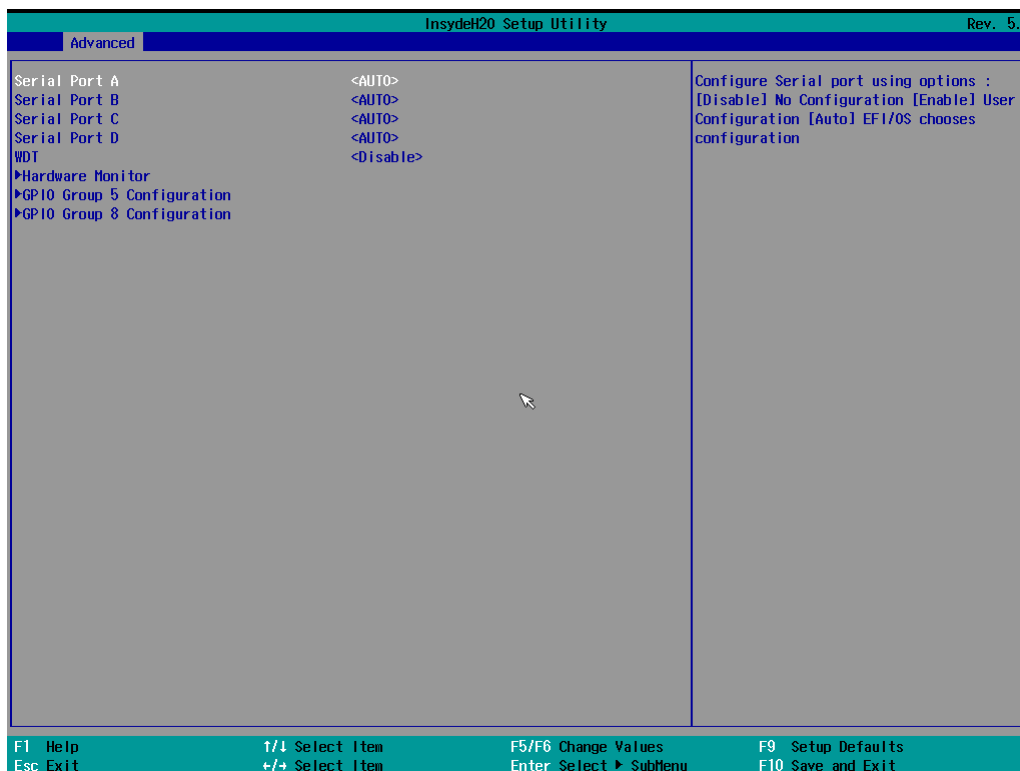

4.2.2.3 GPIO Configuration

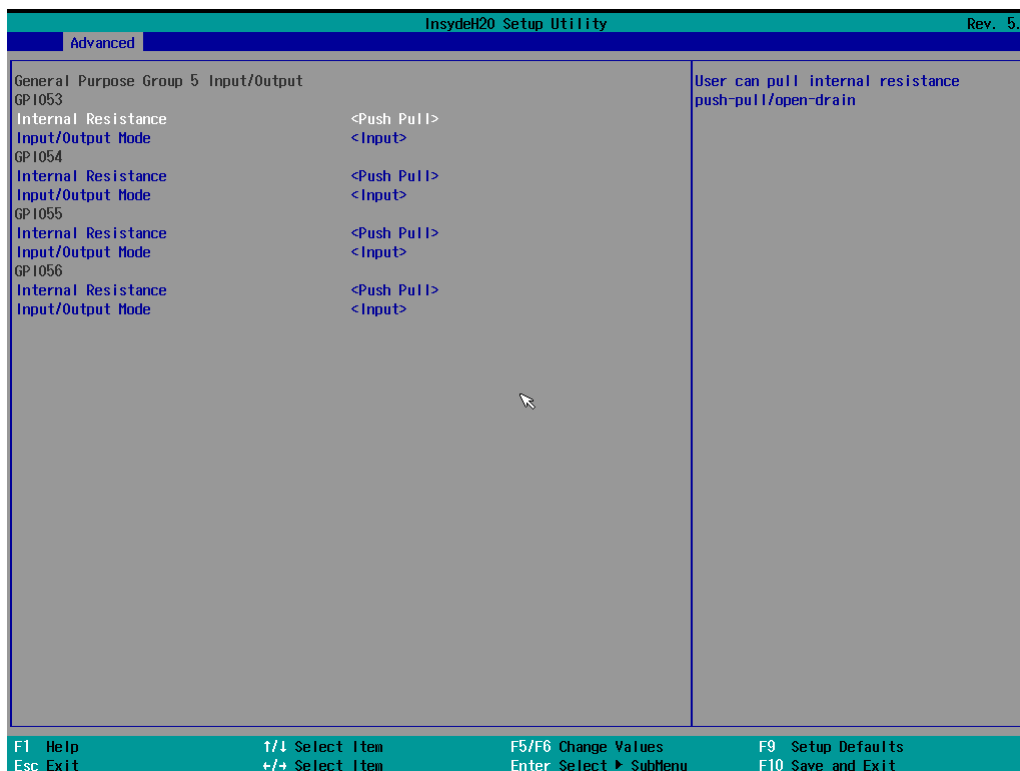



4.2.2.4 Hardware Monitor



4.2.2.5 PCH-IO Configuration

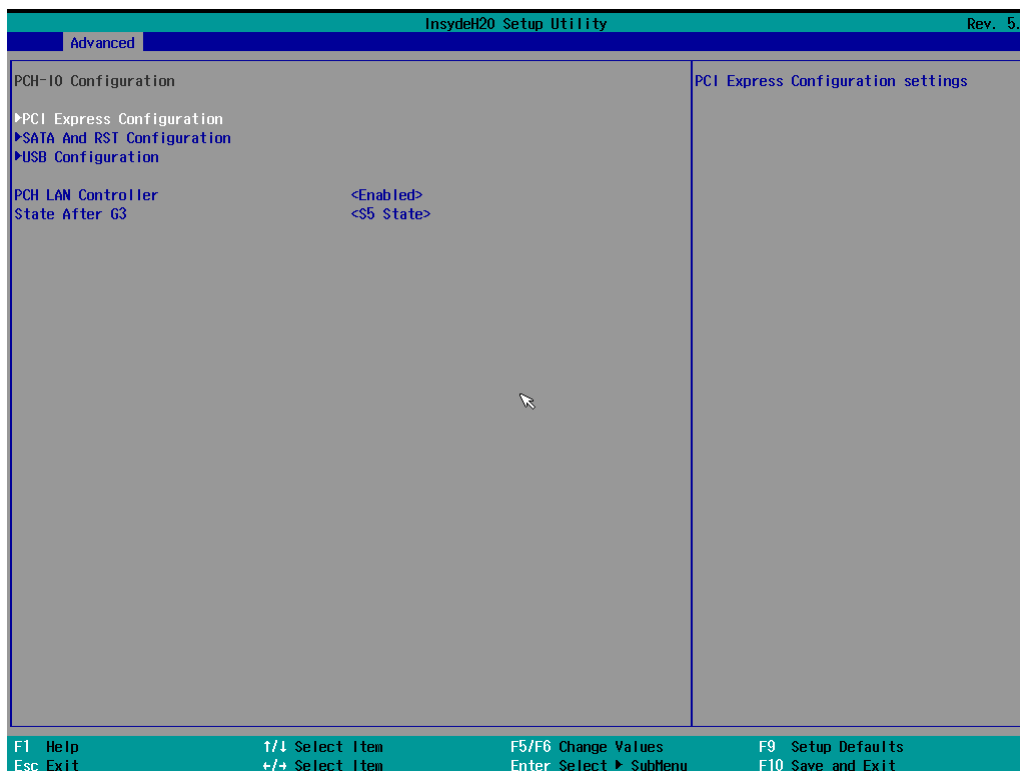

BIOS Setting	Description	Setting Option	Effect
PCI Express Configuration	PCI Express clock gating enable/disable for each root port.	Enter	Opens sub-menu
SATA And RST Configuratuion	Enable/ Disable SATA device	Enter	Opens sub-menu
USB Configuration	Selectively enable/disable the corresponding USB port from reporting a Device Connection to the controller.	Enter	Opens sub-menu
State After G3	System power state setting	S0 State S5 State	

4.2.2.6 PCI Express Configuration

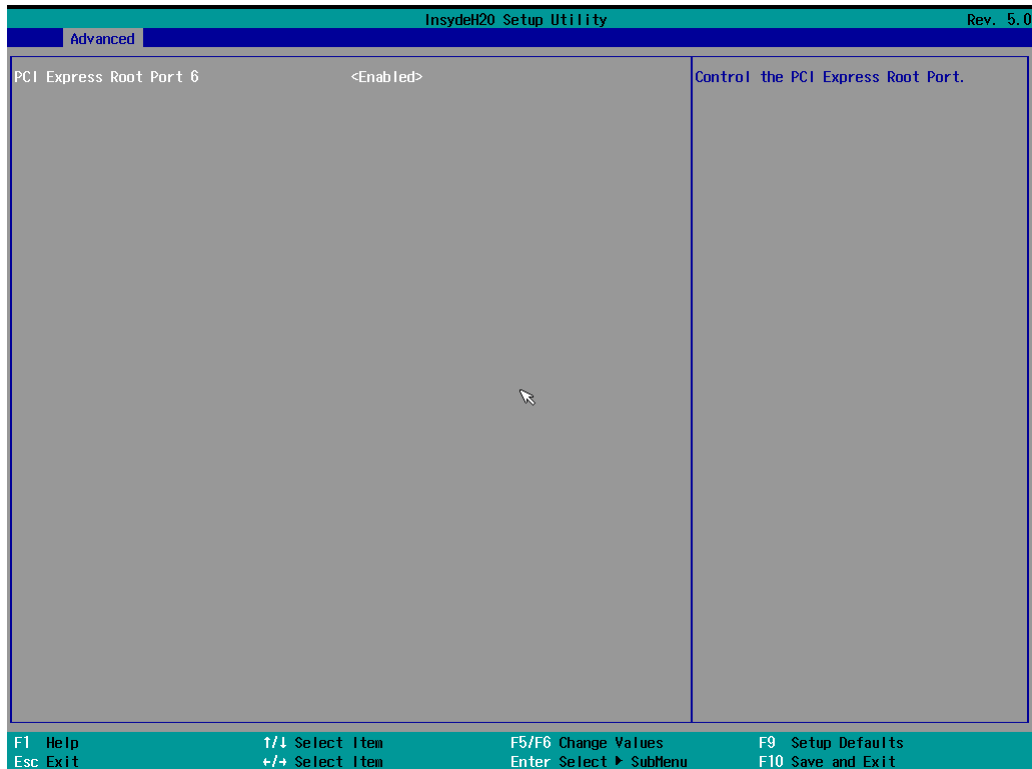
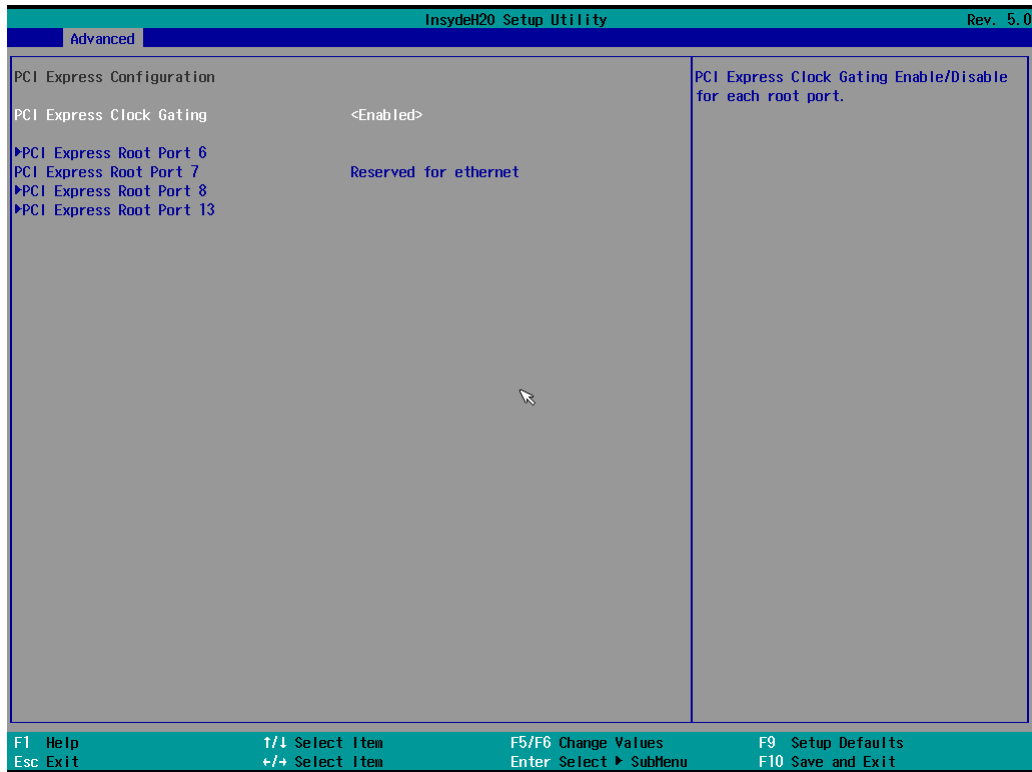

4.2.2.7 SATA and RST Configuration

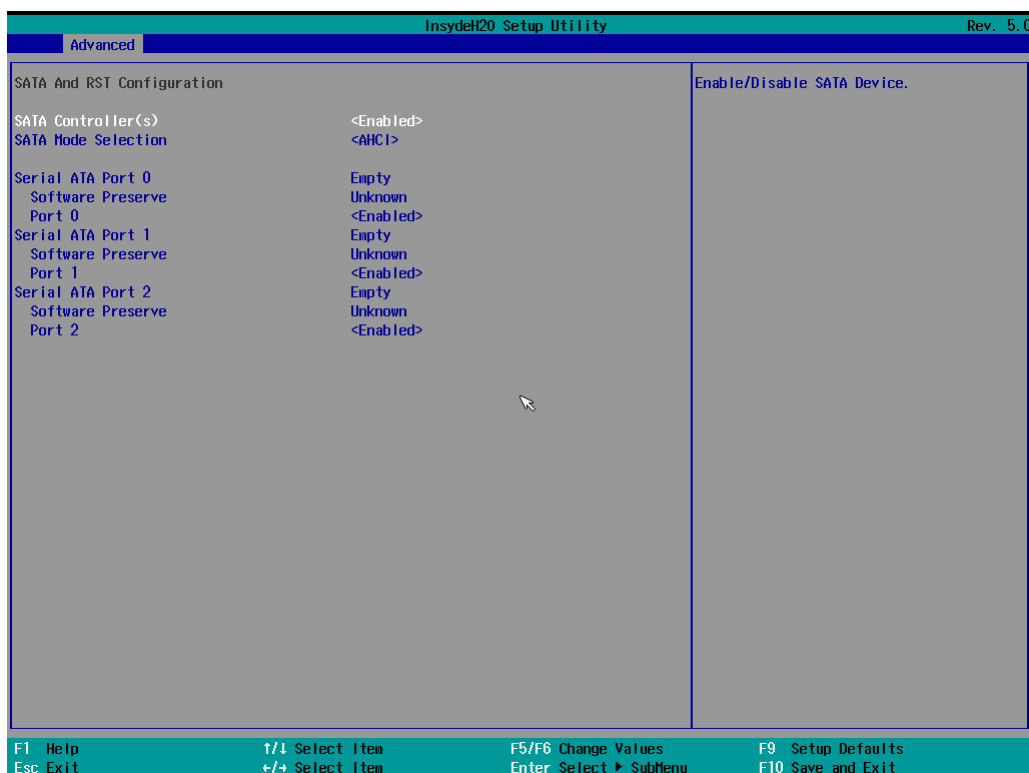

4.2.2.8 USB Configuration

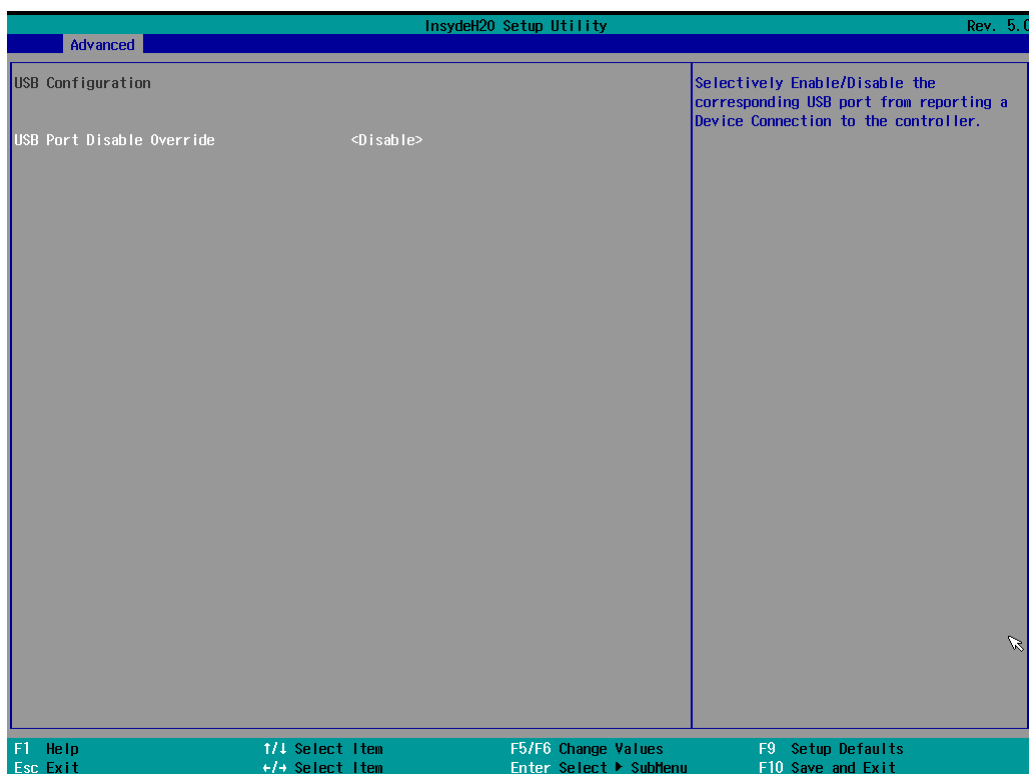

4.2.2.9 ME Firmware Configuration

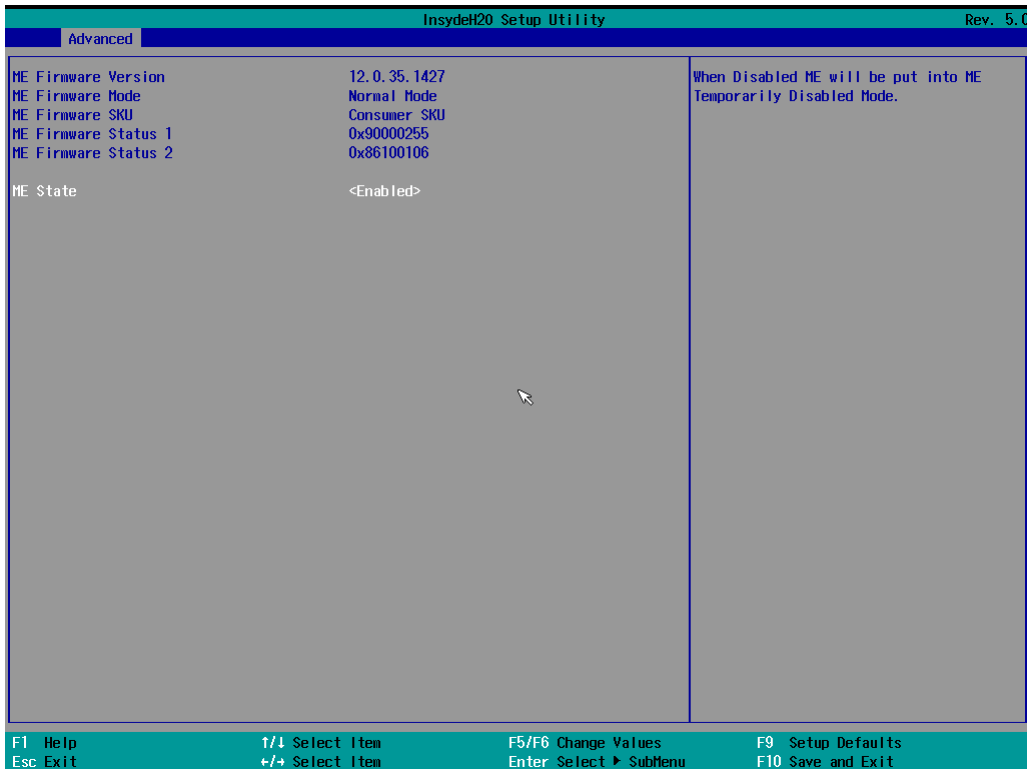

4.2.2.10 Power & Performance

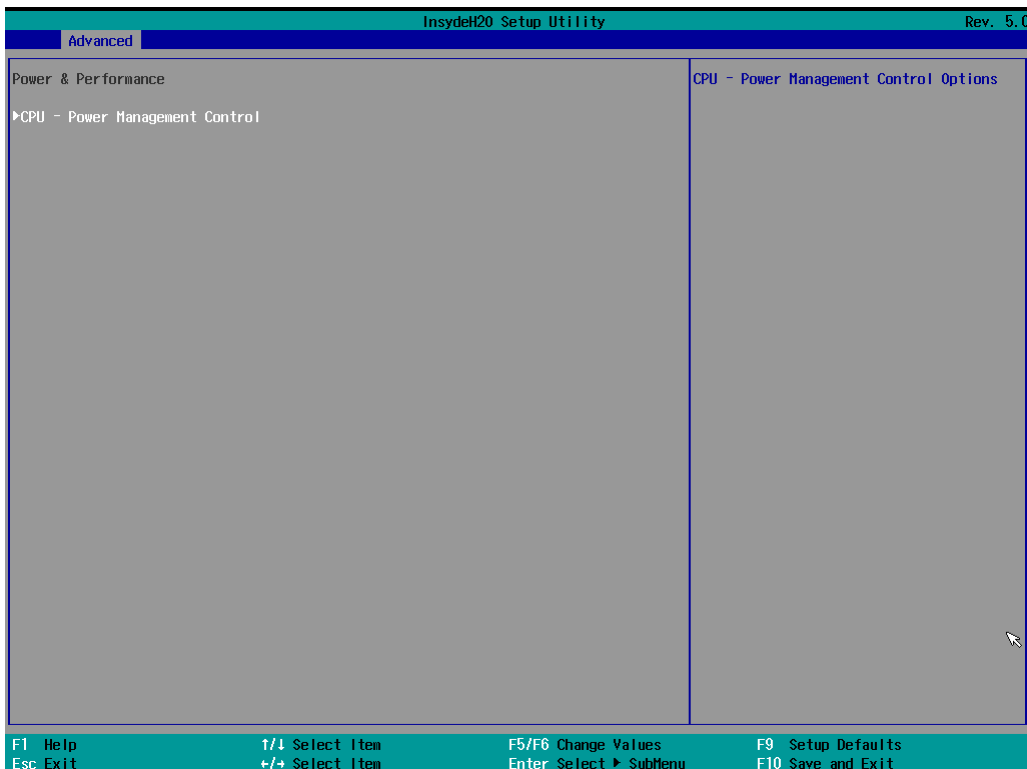

BIOS Setting	Description	Setting Option	Effect
CPU – Power Management Control	Configure CPU – Power Management parameters	Enter	Opens sub-menu

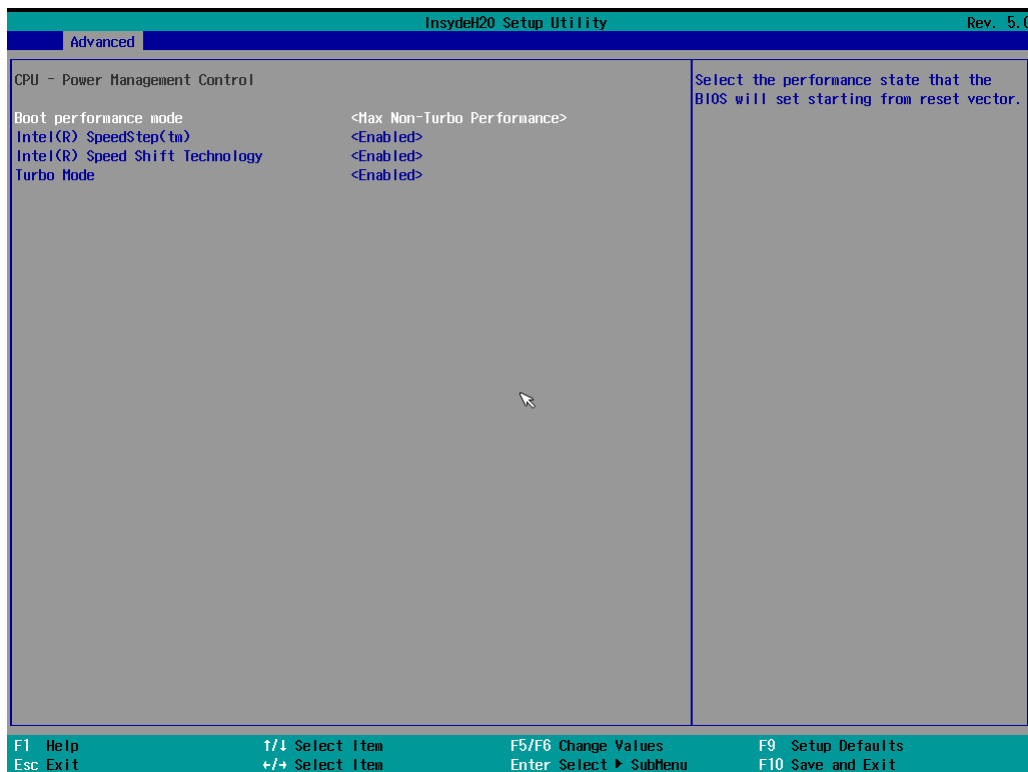

BIOS Setting	Description	Setting Option	Effect
Boot Performance Mode	Configure Boot Performance Mode parameters	-Max non-turbo performance -Max battery -Turbo Performance	Select the performance state that the BIOS will set starting from reset vector
Intel SpeedStep (ta)	Configure Intel SpeedStep parameters	Enabled/ Disabled	Allows more than two frequency ranges to be supported
Intel Speed Shift Technology	Configure Intel Speed Shift Technology parameters	Enabled/ Disabled	Enable/ Disable Intel Speed Shift Technology support. Enabling will expose the CPP v2 interface to allow for hardware controlled P-states
-Turbo Mode	Enable or disable Turbo Mode	Enabled/ Disabled	Enable/ Disable processor Turbo Mode (requires EMTTM enabled too). Auto means enabled, unless max turbo ratio is bigger than 16 – SKL AO W/A
C states	Enable or disable C states	Enabled/ Disabled	Enable/ Disable CPU Power Management. Allows COU to go to C states when it is not 100% utilized
Custom P-state Table	Configure Custom P-state Table parameters	Enter	Enters sub-menu
-Number of P-states	Select the number of custom P-states.	[Number]	Set the number of custom P-states. At least 2 states must be present

4.2.2.11 System Agent (SA) Configuration

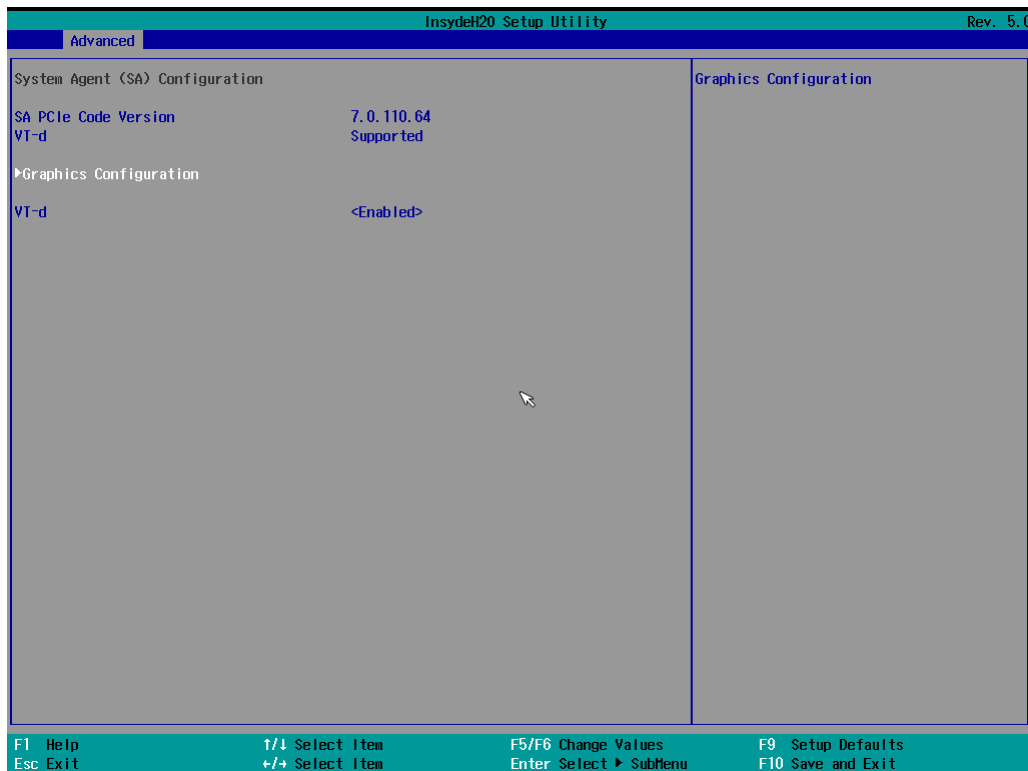

BIOS Setting	Description	Setting Option	Effect
Graphics Configuration	Configure Graphics Configuration parameters	Enter	Opens sub-menu
Vt-d	Intel® Virtualization Technology for Directed I/O	Enabled Disabled	Vt-d capability

4.2.2.11.1 Graphics Configuration

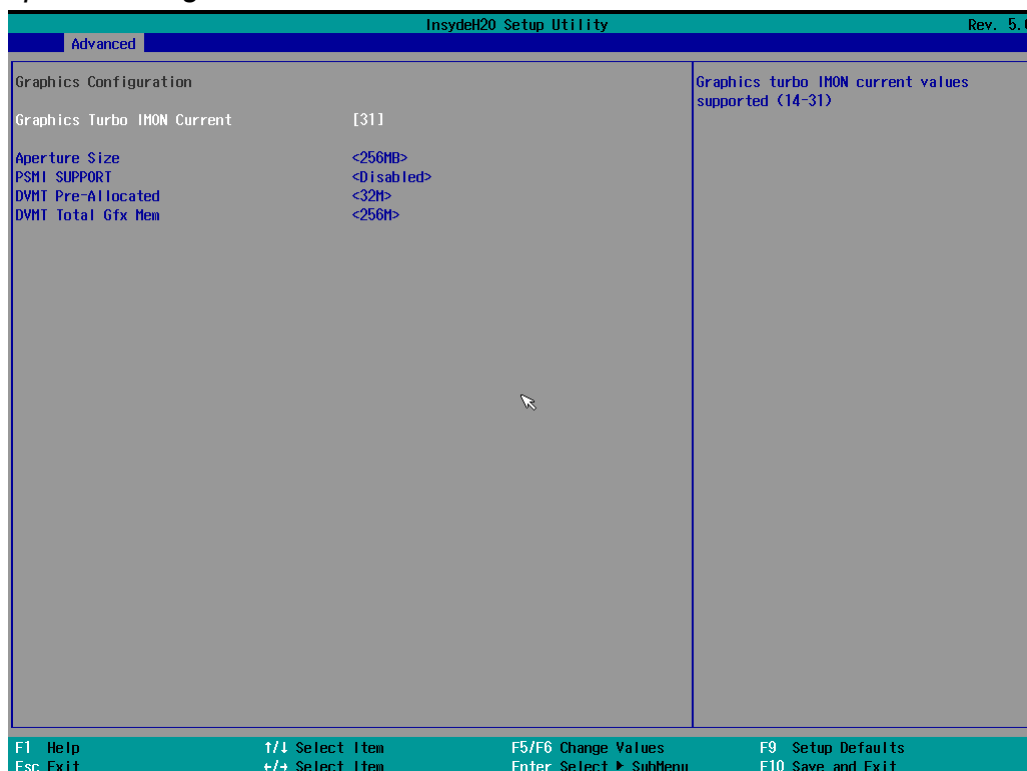

BIOS Setting	Description	Setting Option	Effect
Internal Graphics	Internal Graphics settings	Auto Enabled Disabled	Keep IGFX enabled based on the setup options
Aperture Size	Select the aperture size	128MB 256MB 512MB 1024MB 2048 MB	Select the aperture size <i>Note: Above 4MB MMIO BIOS assignment is automatically enabled when selecting 2048MB aperture. To use this feature please disable CSM port</i>
DVMT Pre-Allocated	Select DVMT Pre-Allocated	0M~60M	Select DVMT 5.0 Pre-Allocated (Fixed) Graphic Memory size used by Internal Graphic Device
DVMT Total Gfx Mem	Select DVMT Total Gfx Mem	256M 128M MAX	Select DVMT 5.0 Total Graphic Memory size used by the Internal Graphic Device
Gfx Low Power Mode	Select Gfx Low Power Mode	Enabled/ Disabled	This option is applicable for SFF only

4.2.2.11.2 Vt-d

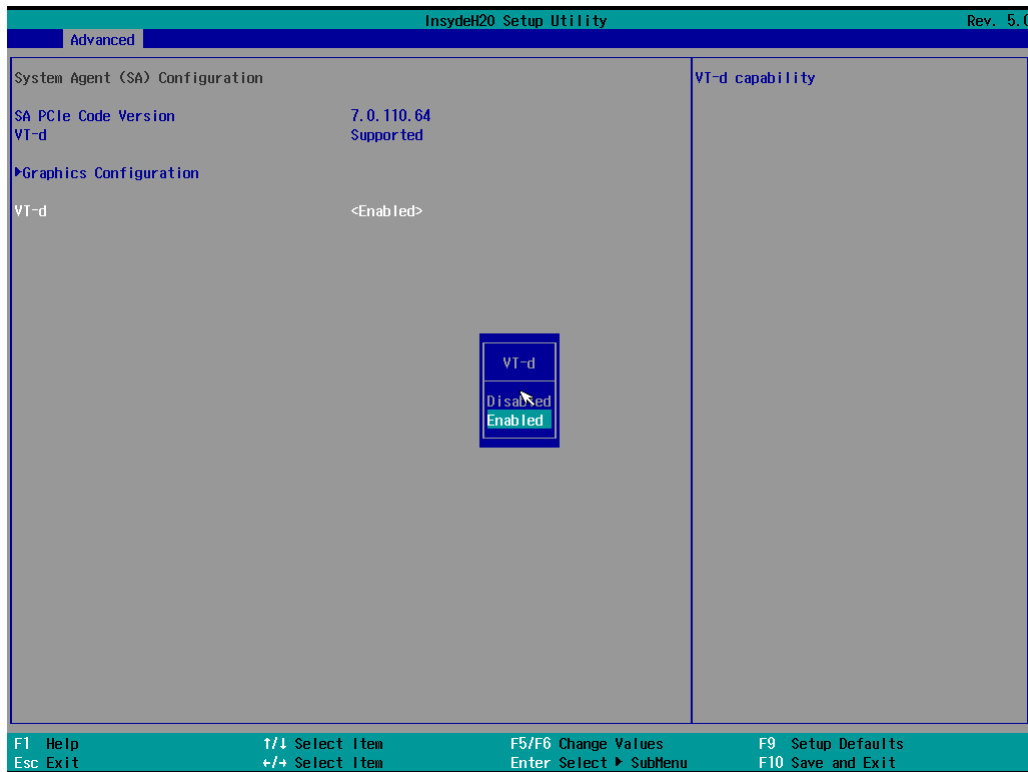

BIOS Setting	Description	Setting Option	Effect
Vt-d	Intel® Virtualization Technology for Directed I/O	Enabled Disabled	Vt-d capability

4.2.3 Boot

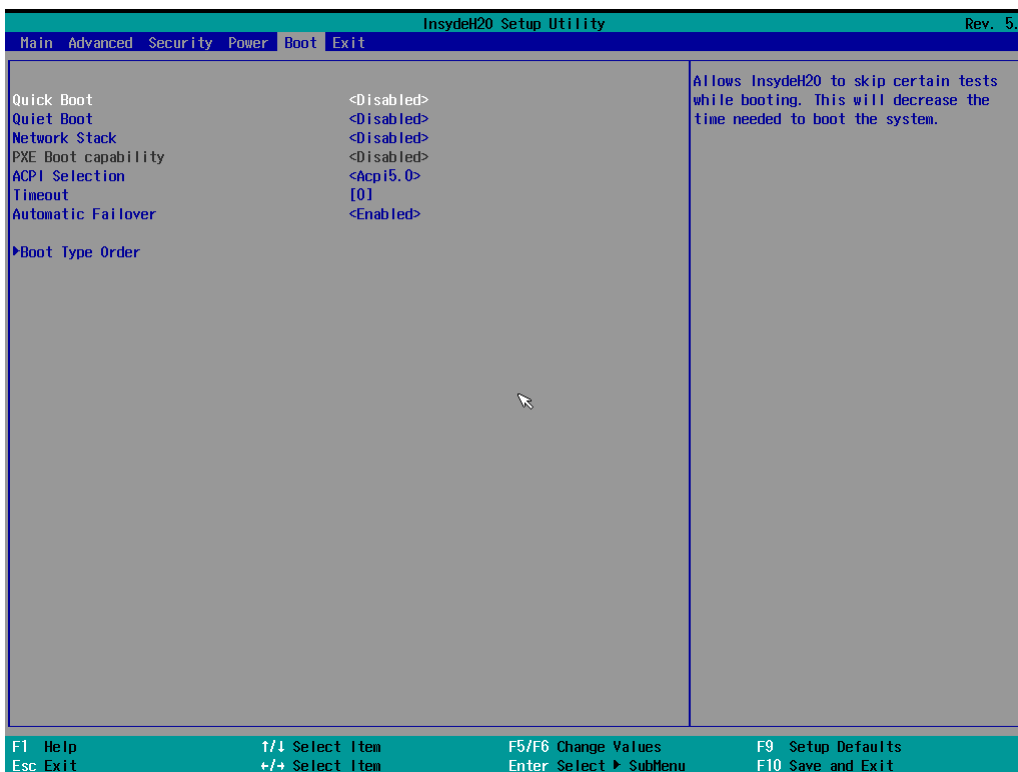

BIOS Setting	Description	Setting Option	Effect
Boot Type	Boot Type configuration	UEFI Boot Type	Select boot type to Dual type, Legacy type or UEFI type
Quick Boot	Quick Boot configuration	Enabled Disabled	Allows InsydeH20 to skip certain tests while booting. This will decrease the time needed to boot the system
Quiet Boot	Quiet Boot configuration	Enabled Disabled	Disable or enable booting in text Mode.
Timeout	Timeout	[Value]	Timeout settings
Automatic Failover		Enable	If boot to default device fail, it will directly try to boot next device
		Disable	If boot to default device fail, it will pop warning message then go to firmware UI
Boot Type Order	Boot Type Order	Enter	Opens sub-menu

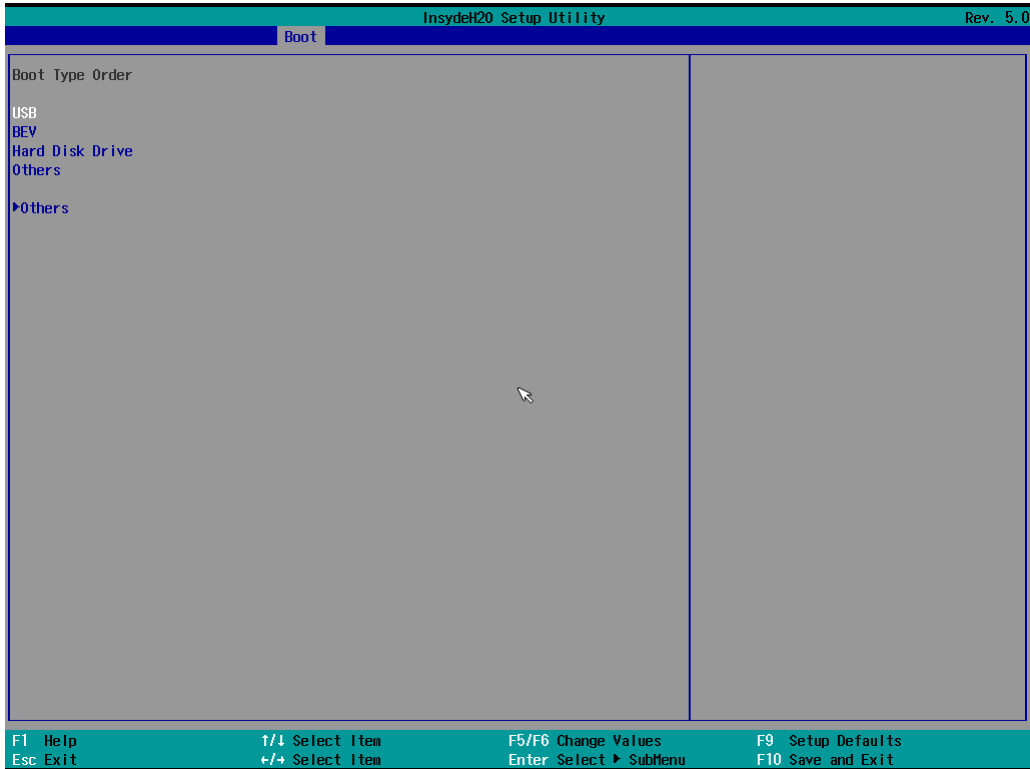

4.2.3.1 Boot Type Order

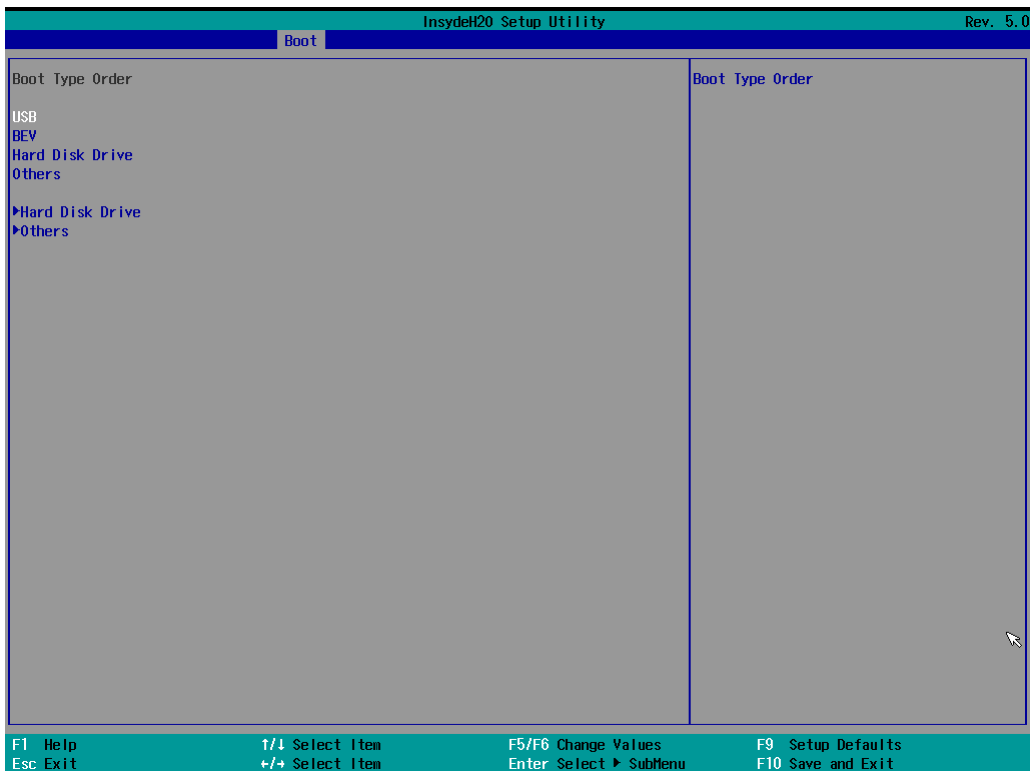

BIOS Setting	Description	Setting Option	Effect
Hard Disk Type	Hard Disk Type configuration	Enter	Opens Sub-menu
Others	Other configuration	Enter	Opens Sub-menu

4.2.3.1.1 Others

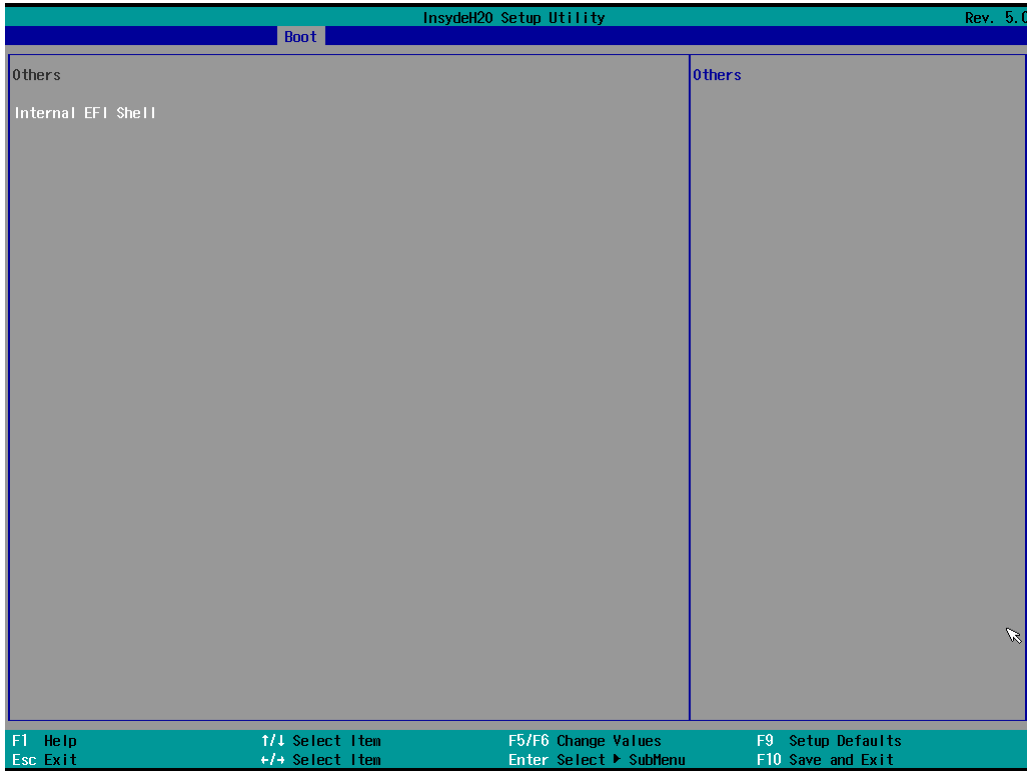

4.2.4 Security

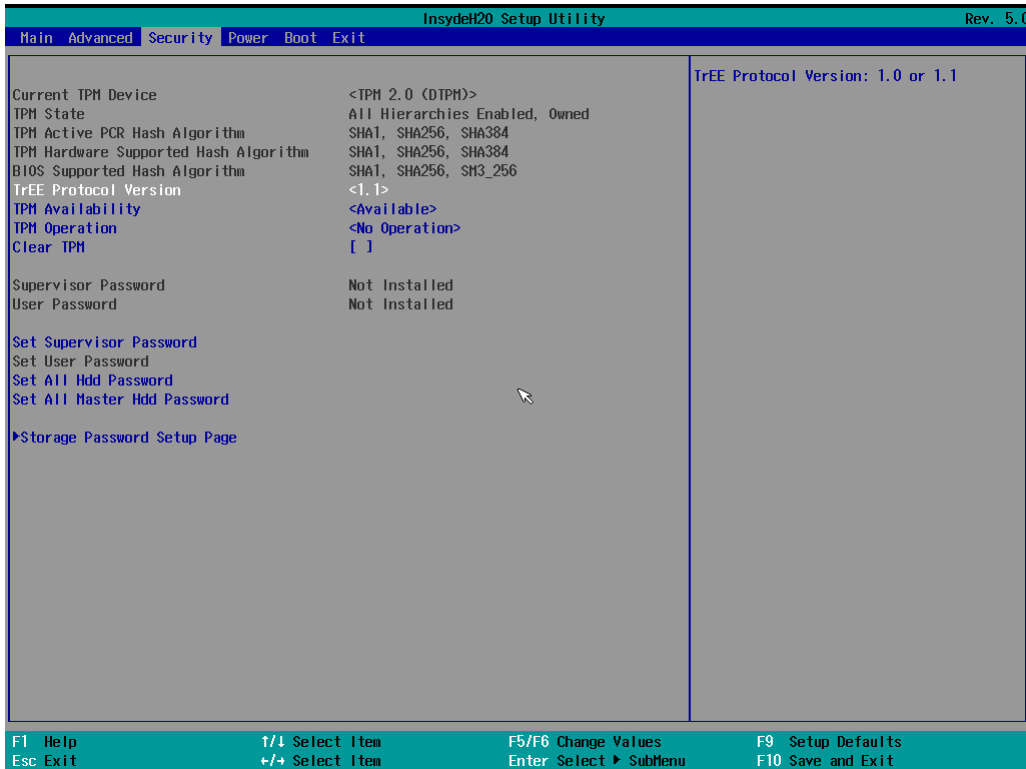

BIOS Setting	Description	Setting Option	Effect
TrEE Protocol Version	Choose TrEE Protocol Version	1.0 1.1	TrEE Protocol Version: 1.0 or 1.1
TPM Availability	TPM Availability configuration	Available Hidden	When hidden don't exposes TPM to 0
TPM Operation	TPM Operation configuration	[]	Select one of the supported operation to change TPM2state
Clear TPM	Clear TPM configuration	[]	Select to Clear TPM
Set Supervisor Password	Set Supervisor Password	Enter New password	Install or Change the password and the length of password must be greater than one character

4.2.5 Power

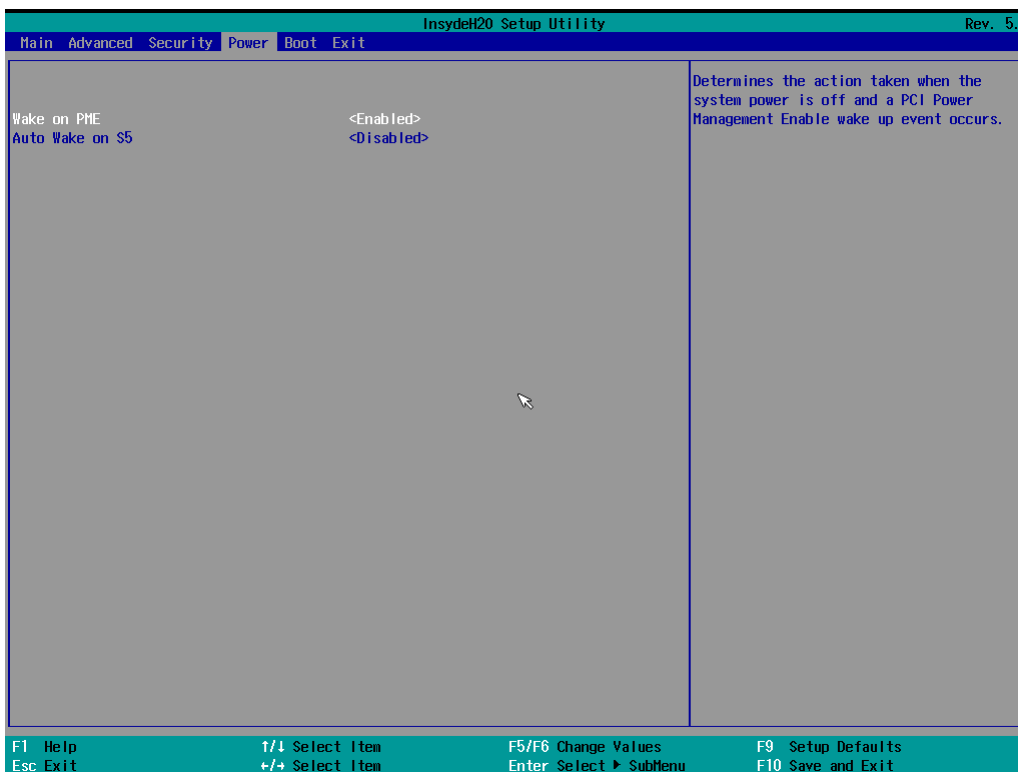

BIOS Setting	Description	Setting Option	Effect
ACPI S3	ACPI S3 configuration	Disabled Enabled	Enable/ Disable ACPI S1/S3 Sleep state
Auto Wake on S5	Auto Wake on S5 configuration	Disabled By Every Day By Every Month	Auto Wake on S5, by Day or Month or fixed time of every day

4.2.6 Exit

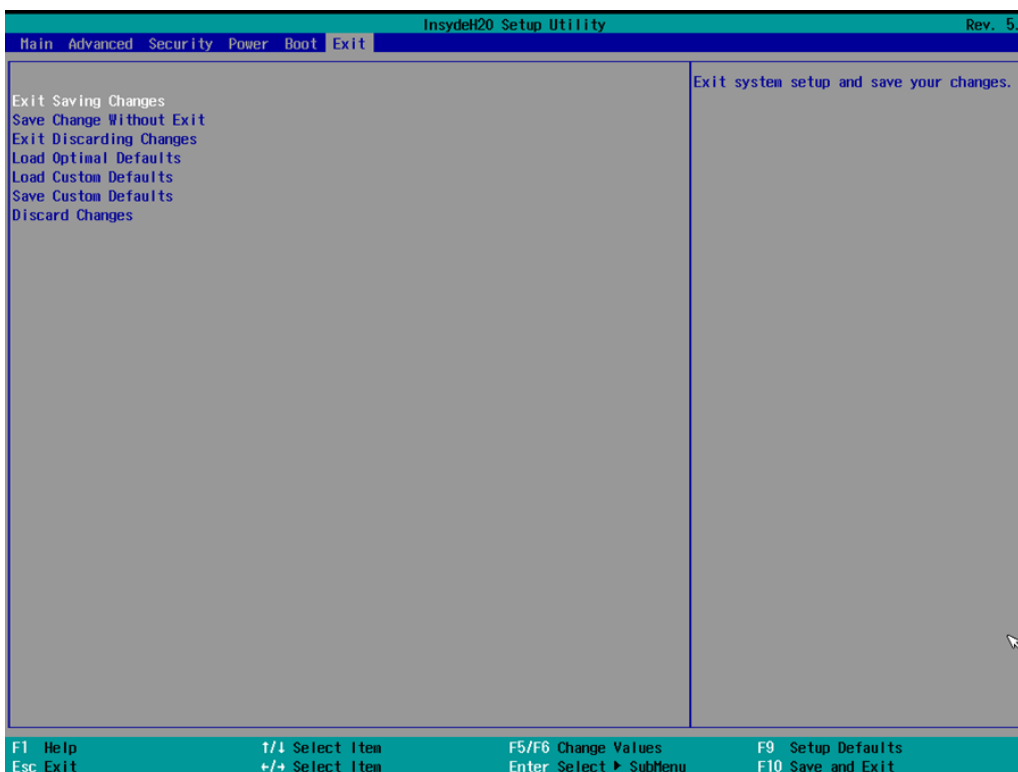

4.3 Using Recovery Wizard to Restore Computer

The Panel PC has a dedicated recovery partition stored on the hard drive of the PC to enable quick one-key recovery process. This partition occupies about 11GB of the storage space, and comes built-in to the PC.



Note:

Before starting the recovery process, make sure to backup all user data. The data will be lost after the recovery process.

To enable quick one-key recovery procedure:

- Plug-in the AC adapter to Bay Trail series computer. Make sure the computer stays plugged in to power source during the recovery process.
- Turn on the computer, and when the boot screen shows up, press the **F6** to initiate the Recovery Wizard.
- The following screen shows the Recovery Wizard. Click **Recovery** button to continue.



A warning message about data loss will show up. Make sure the data is backed up before recovery, and click **Yes** to continue.



Wait the recovery process to complete. During the recovery process, a command prompt will show up to indicate the percent of recovery process complete. The system will restart automatically after recovery completed.

Chapter 5: Driver Installation

This chapter provides guideline to driver installations.

5.1 Installing Chipset Driver

Follow instructions below to install Chipset driver.

1. Open the Driver CD (included in the package) and select **Chipset** driver.

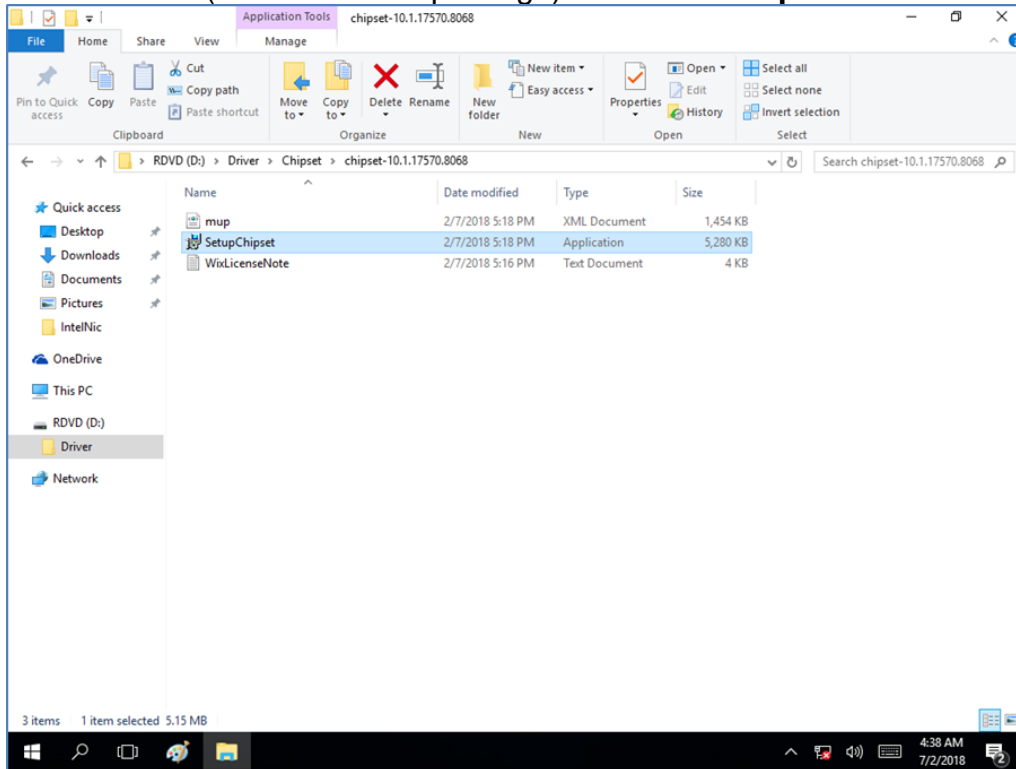

2. Installation window will pop up, select **Next**.

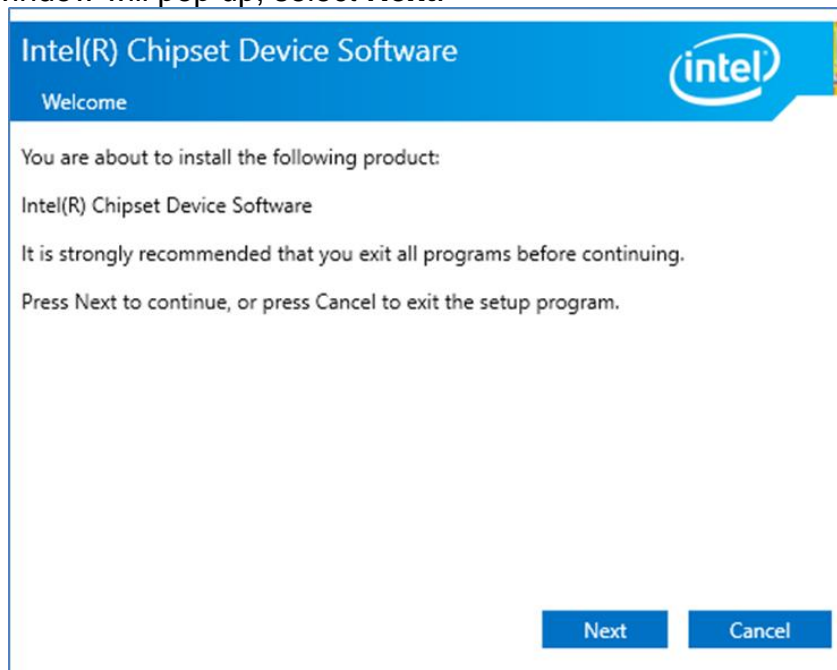

3. Select **Accept** to agree with the terms of license agreement.



4. Check the ReadMe file information, select **Install** to continue.



5. Wait for the driver to be installed. When installation completed, select **Restart Now** to restart your computer.



5.2 Graphic Driver

Follow instructions below to install Graphic driver.

1. Open the Driver CD (included in the package) and select **Graphic** driver.

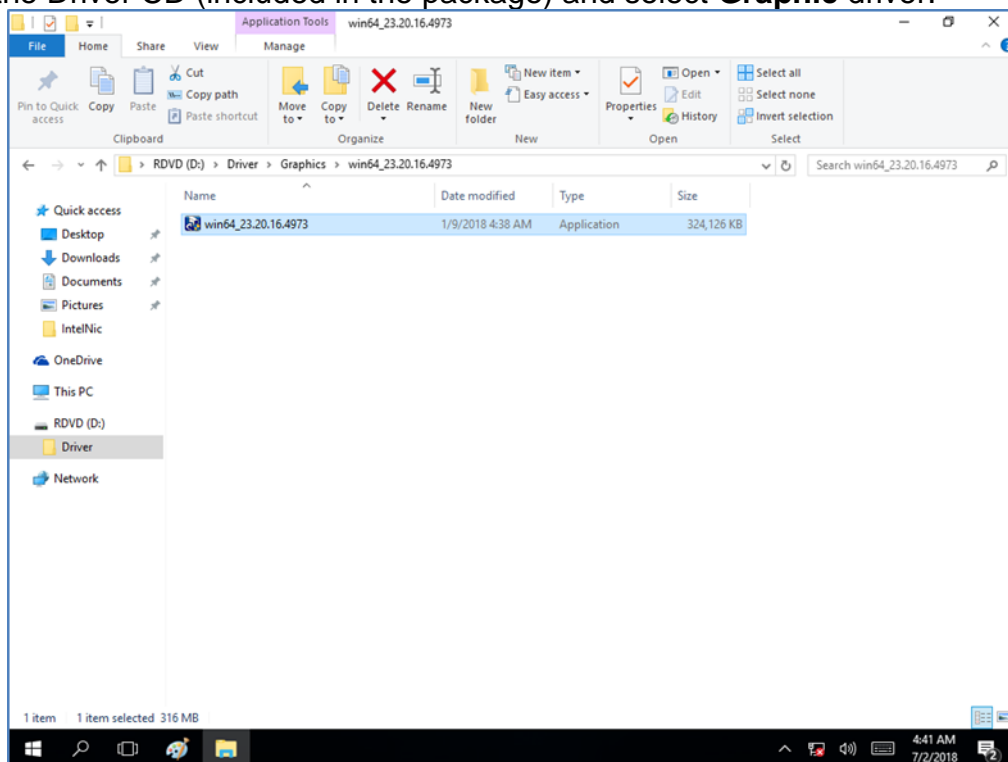

2. Installation window will pop up, select **Next**.

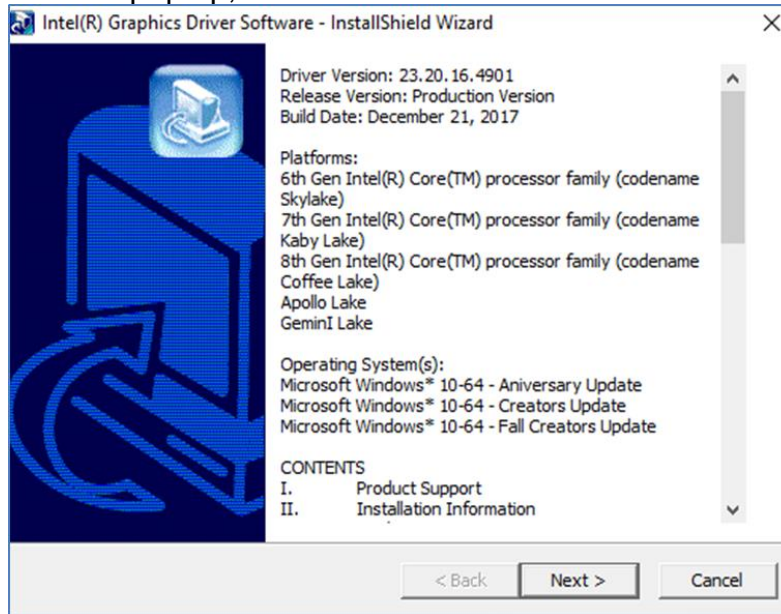

3. Select Accept to agree with the terms of license agreement.

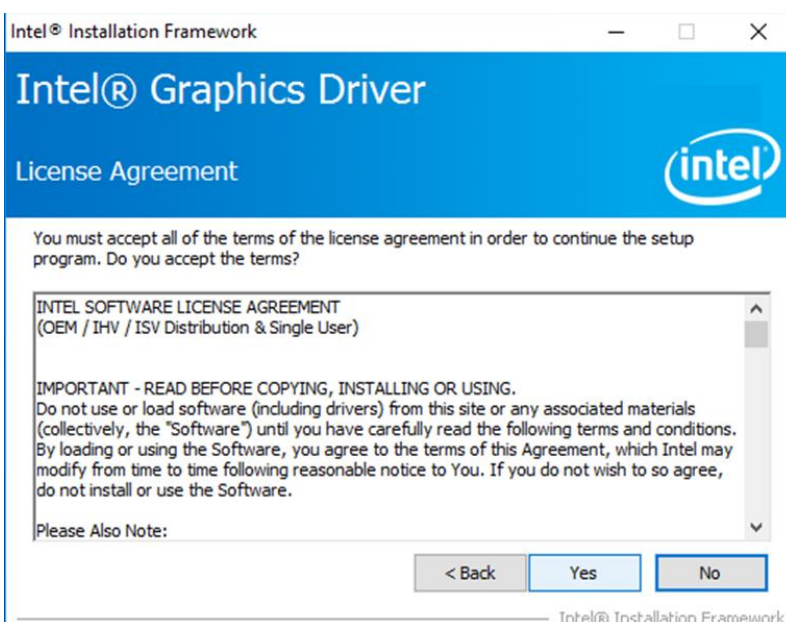
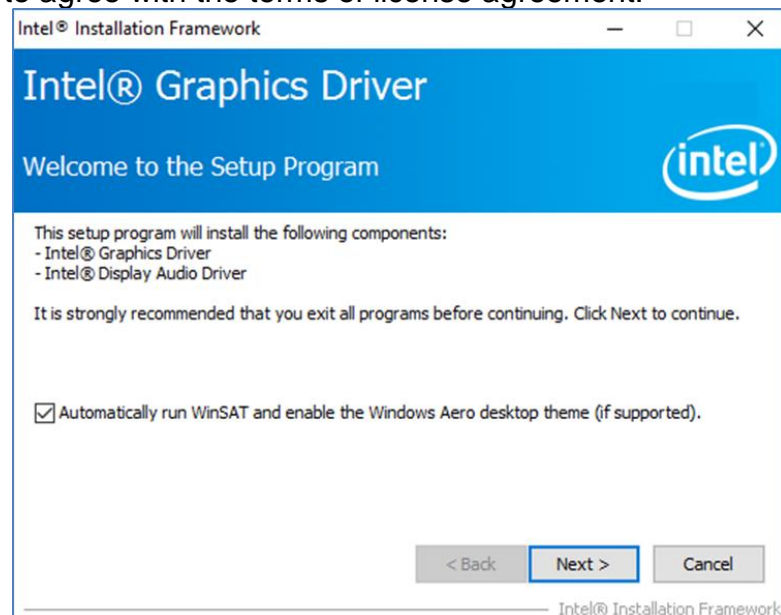

4. Check the ReadMe file information, select **Next** to continue.

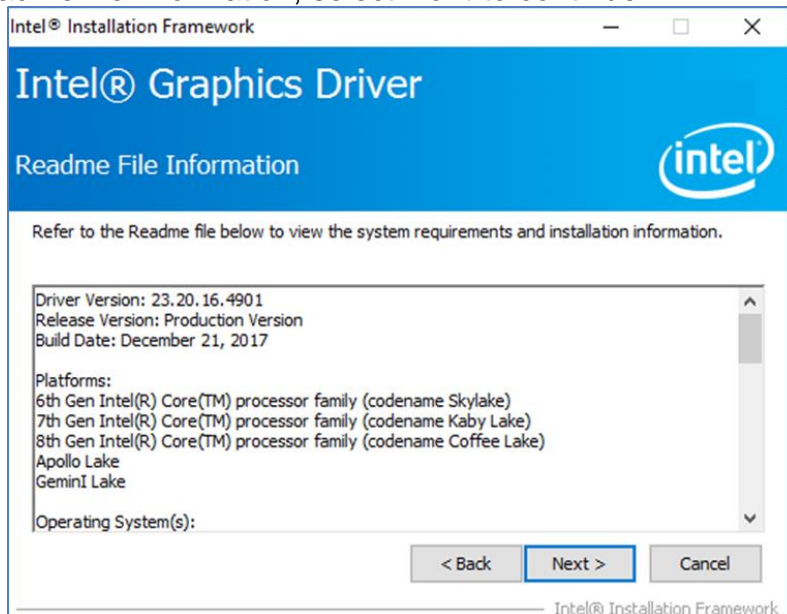

5. Wait for the driver to be installed.

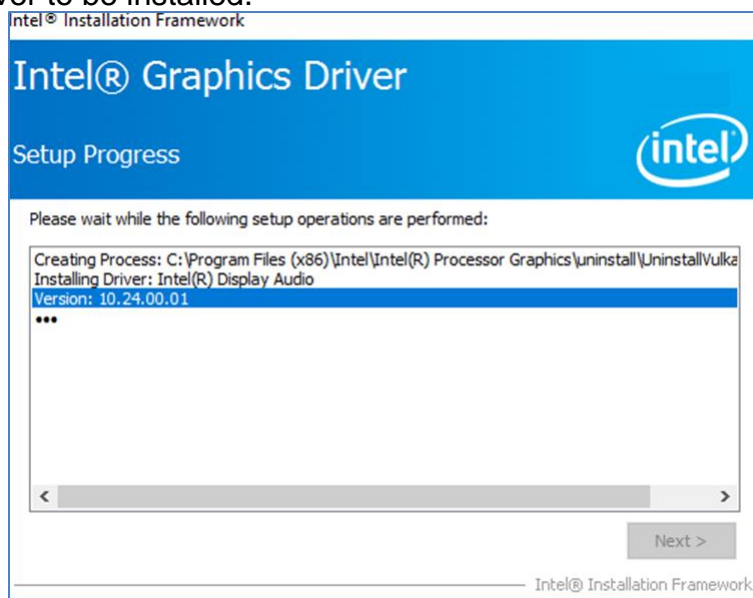

6. Select **Next** to continue.

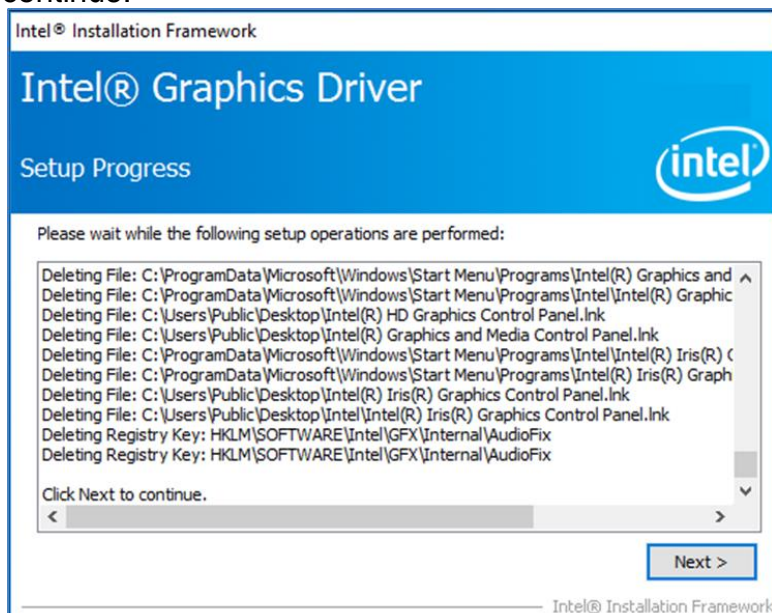

7. After installation is completed, select **“Yes, I want to restart this computer now”**, and click **Finish**.

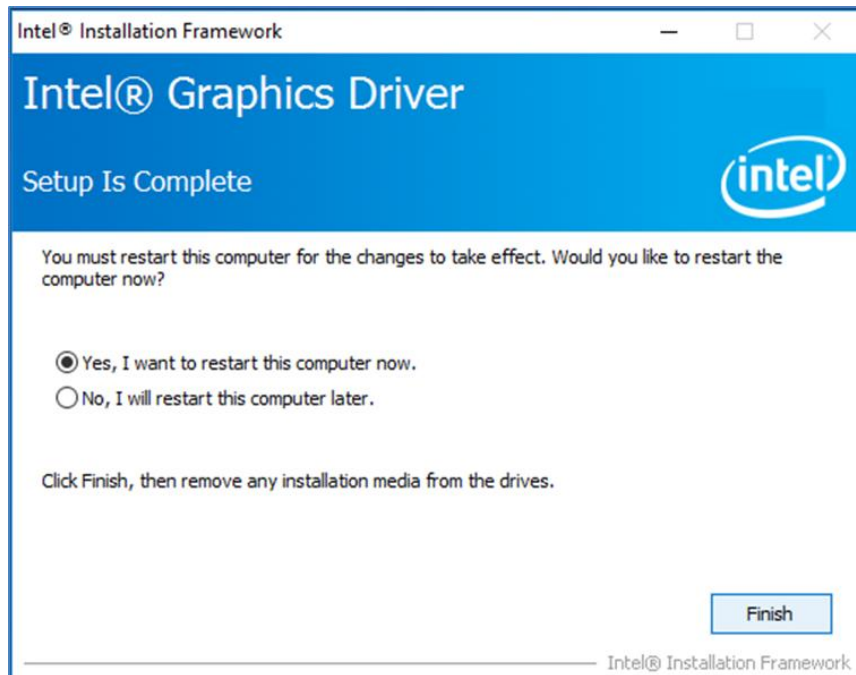

5.3 Management Engine (ME)

Follow instructions below to install Management Engine (ME) .

1. Open the Driver CD (included in the package) and select **ME** driver.

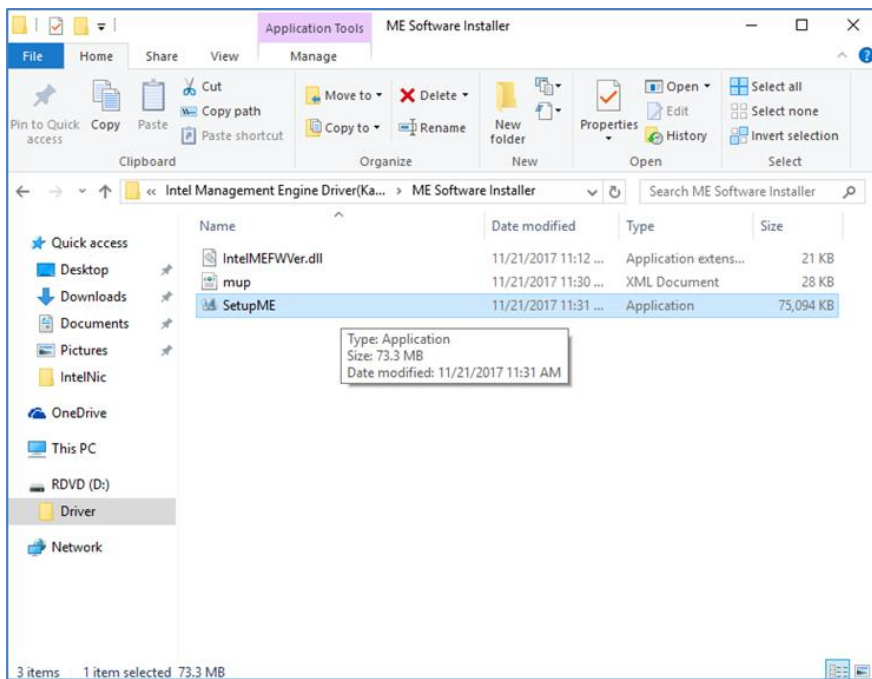

2. Select **Next** to start the installation.

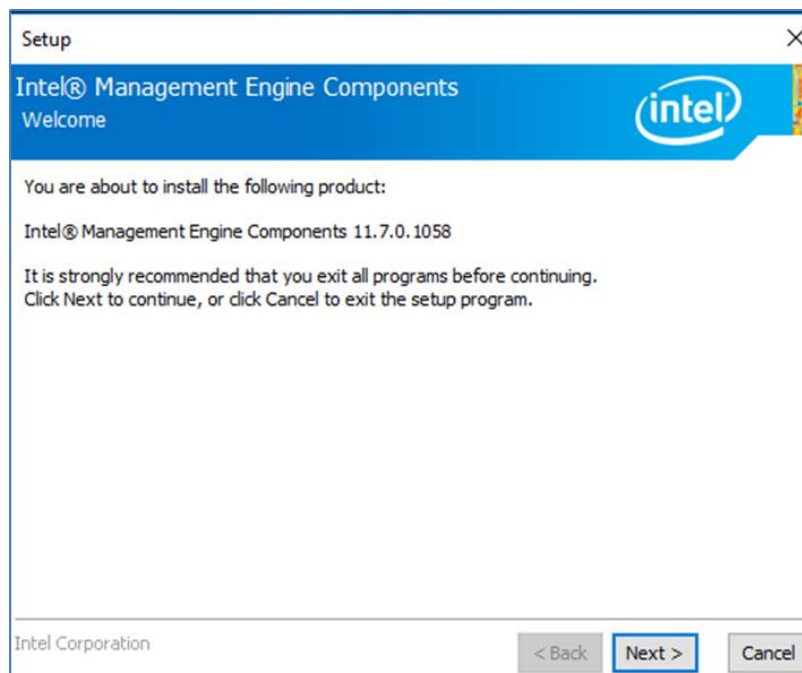

3. Select **Next** to agree with the terms of license agreement.

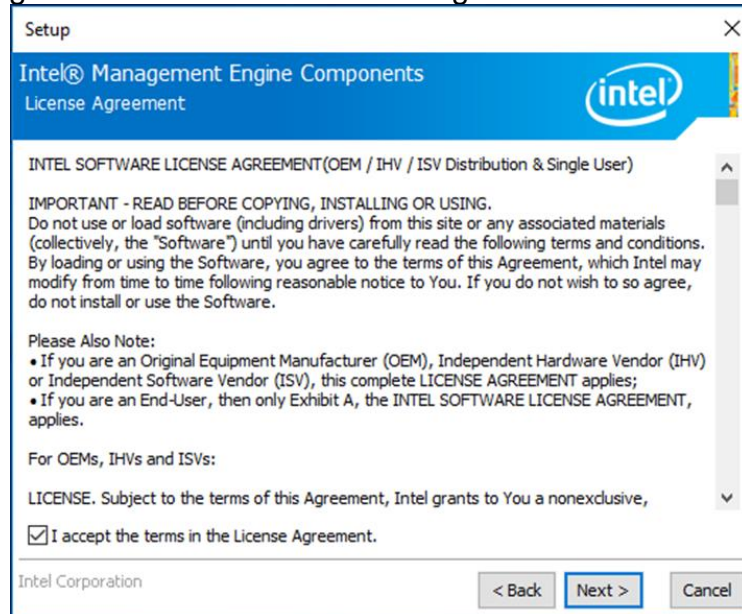

4. Wait for the driver to be installed.

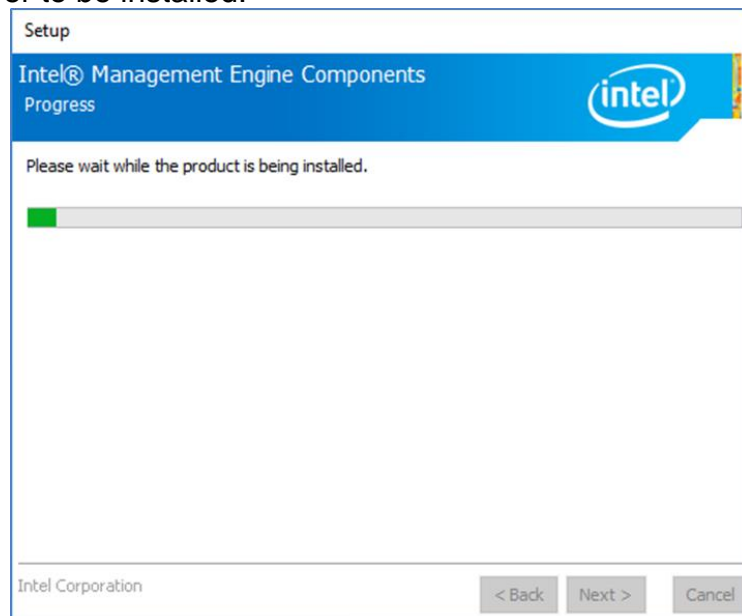

5. When installation completed, select **Finish** complete installation.



5.4 Audio Driver

Follow instructions below to install Audio driver.

1. Open the Driver CD (included in the package) and select **Audio** driver.

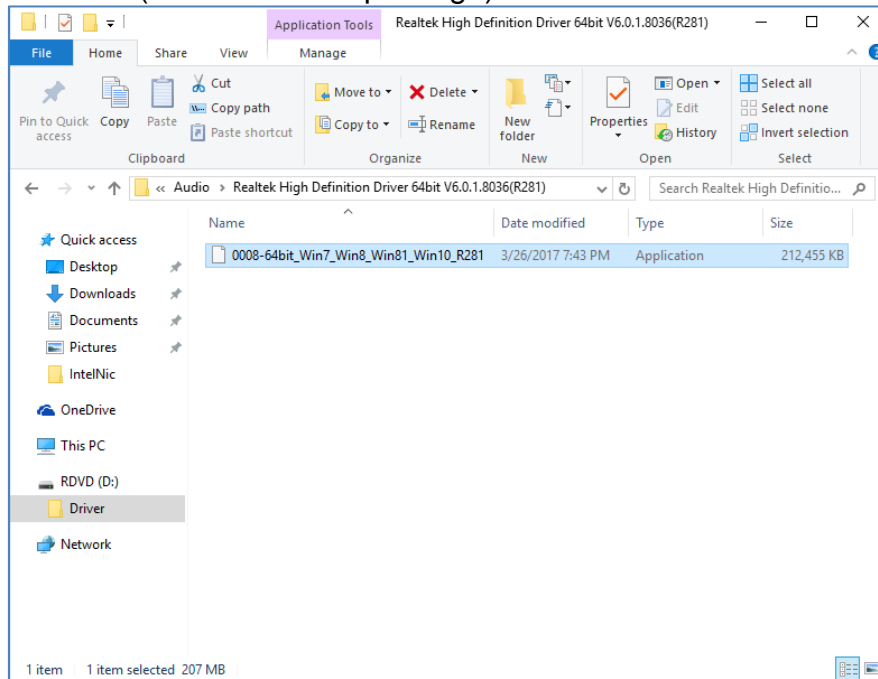

2. Select **Next** to continue.



- When installation completed, select **Finish** complete installation.

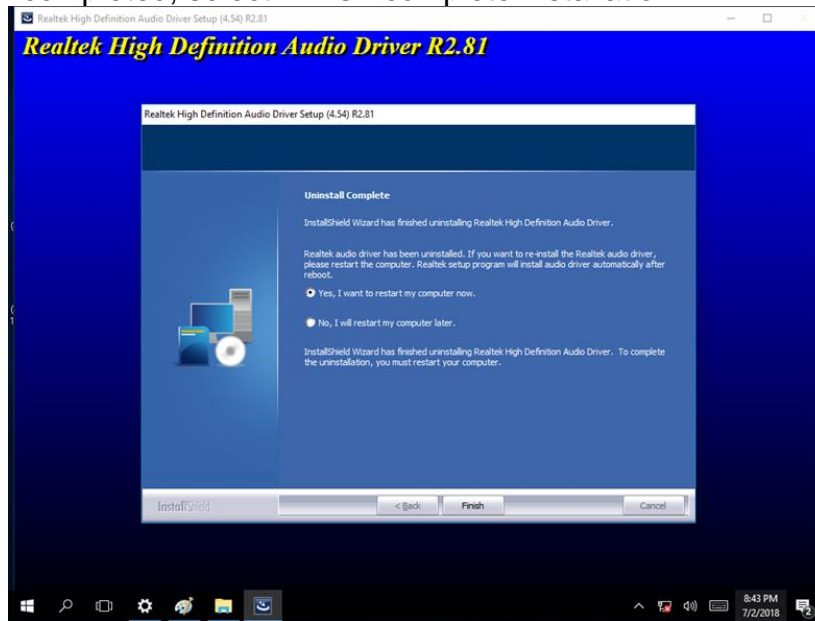

5.5 Ethernet Driver

Follow instructions below to install LAN driver.

- Open the Driver CD (included in the package) and select **LAN** driver.

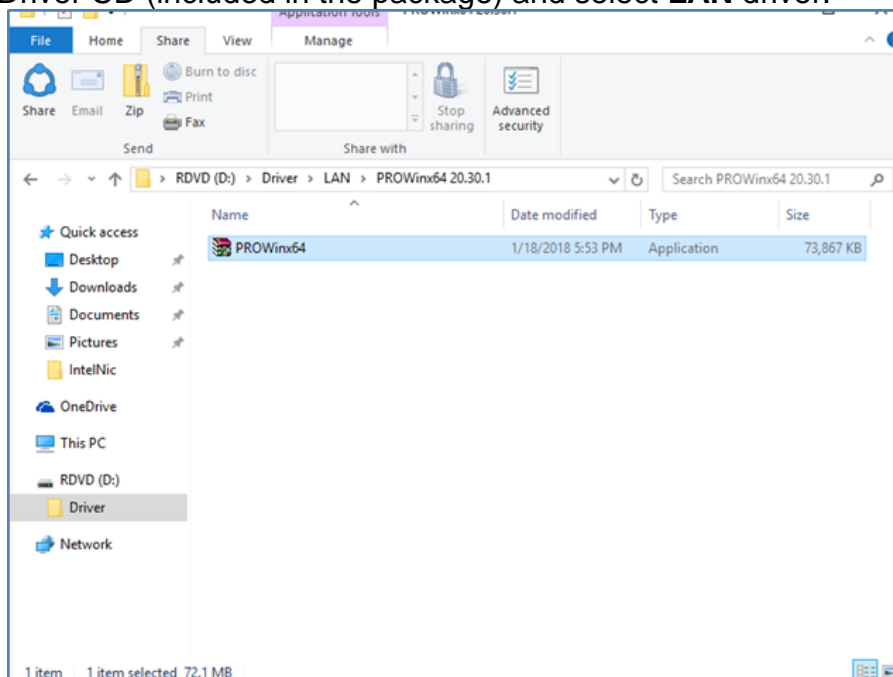

- When compression is complete, select **Next**.

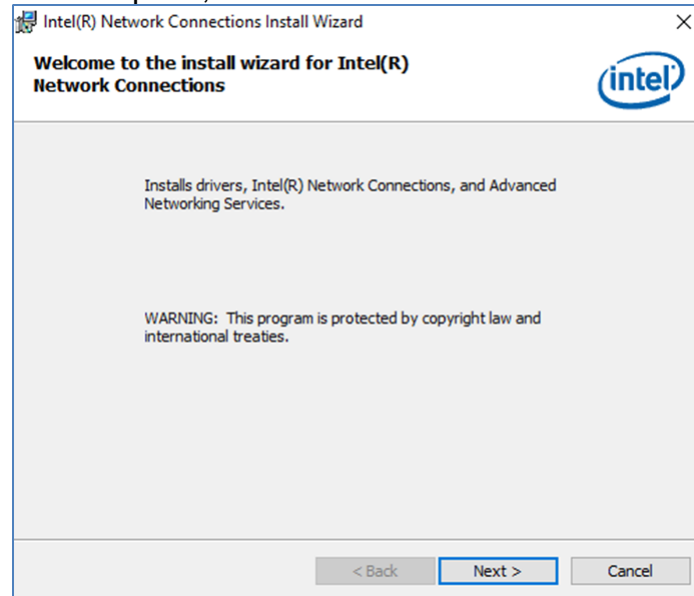

- Read the license agreement, and then select **Next**.

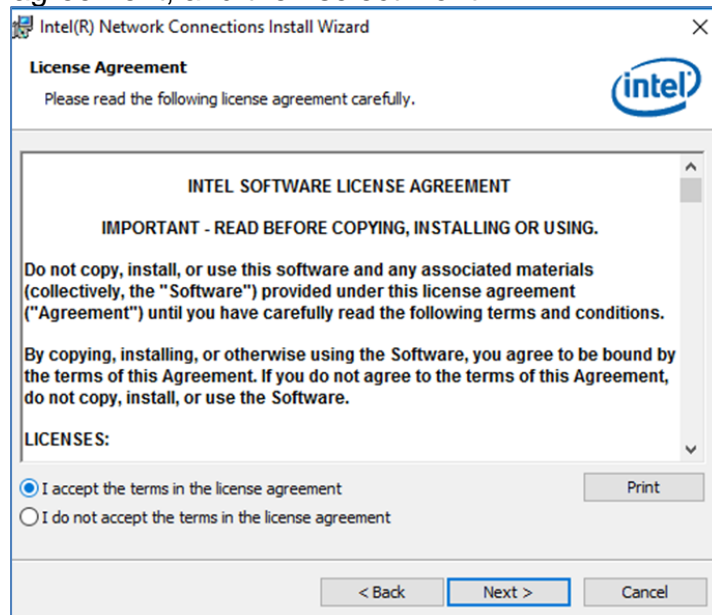

- System displays the installed packages, select **Next**.

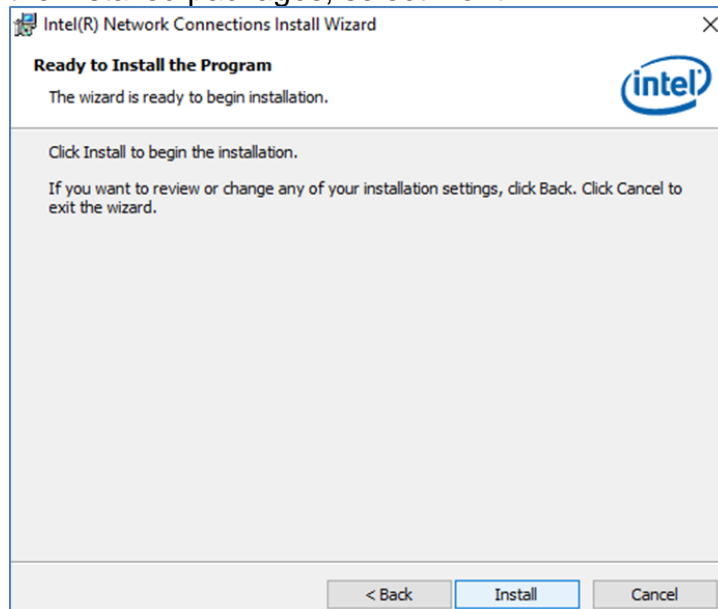

5. Confirm the installation, select **Install** to start the installation.

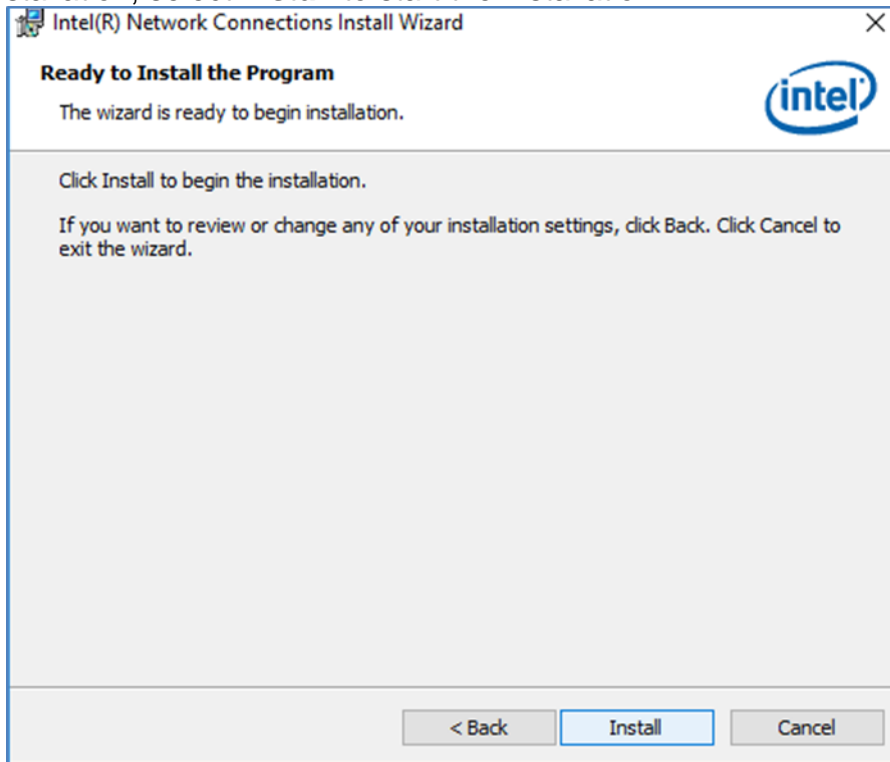

6. When installation is completed, select **Finish** to close the window.

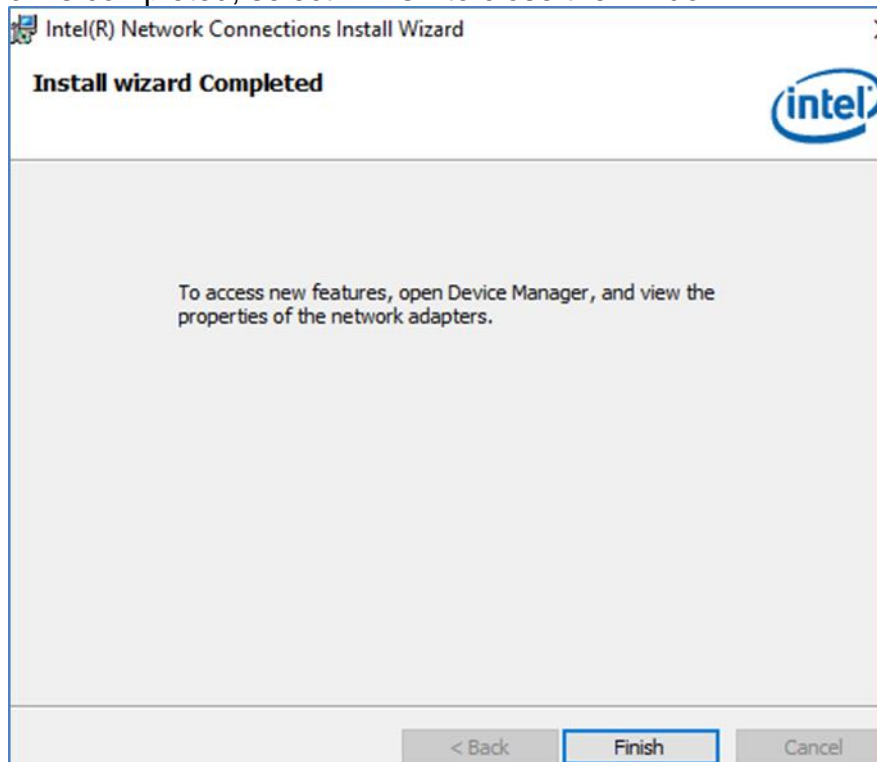

5.6 Watchdog Driver

For more details about Winmate Watchdog, please download Watchdog Guide from Winmate Downloads Center.

http://dc.winmate.com.tw/downloadCenter/2017/Embedded%20Computing/Watchdog%20Guide/IB_IH_IV_IK.pdf

Follow instructions below to install **Watchdog** driver.

1. Type "cmd" in the run box then the cmd.exe will appear in programs.
2. Right click on the cmd.exe and click on "Run as administrator" to start
Open the Driver CD (included in the package) and select Watchdog driver.

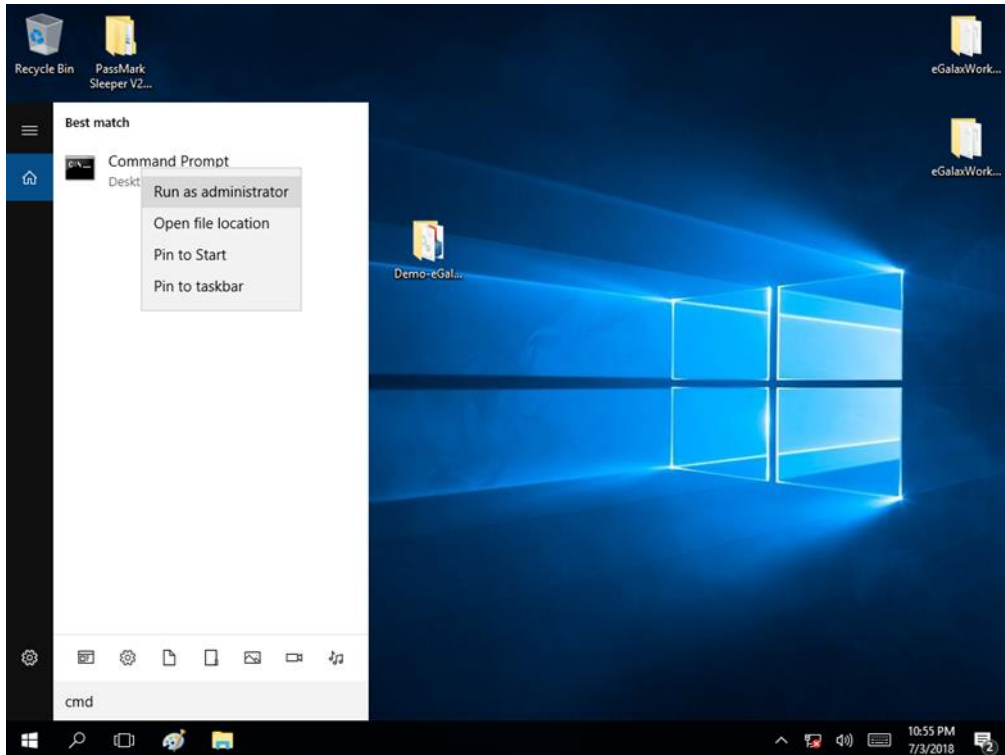

3. When Windows Security dialog appear, select **install** to continue the Installation.

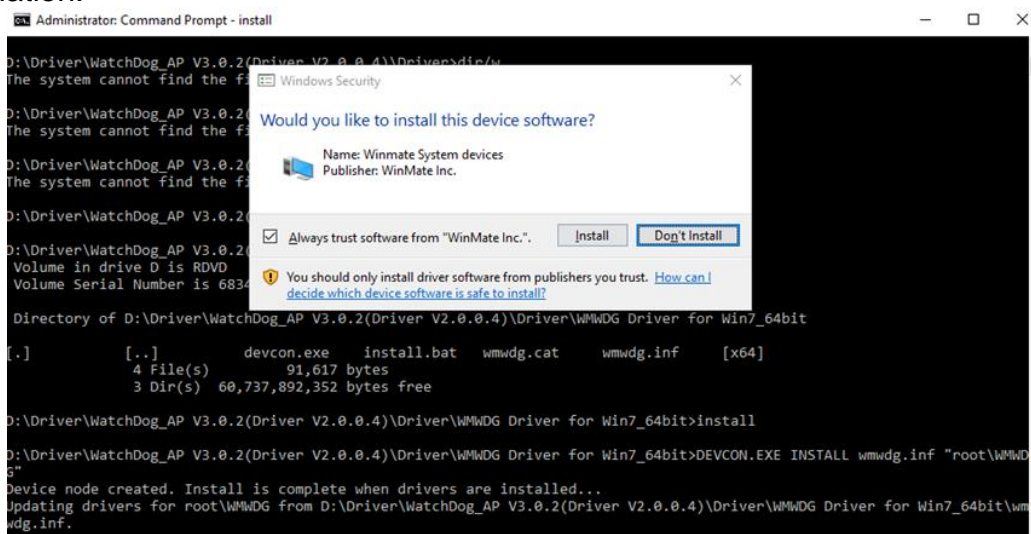

4. Wait for installation to complete. When installation is complete, press any key to close.

```
Administrator: Command Prompt - install
D:\Driver\WatchDog_AP V3.0.2(Driver V2.0.0.4)\Driver>dir
The system cannot find the file specified.

D:\Driver\WatchDog_AP V3.0.2(Driver V2.0.0.4)\Driver>dir/w
The system cannot find the file specified.

D:\Driver\WatchDog_AP V3.0.2(Driver V2.0.0.4)\Driver>cd WMWDG Driver for Win7_64bit

D:\Driver\WatchDog_AP V3.0.2(Driver V2.0.0.4)\Driver\WMWDG Driver for Win7_64bit>dir/w
Volume in drive D is RDVD
Volume Serial Number is 6834-E6A5

Directory of D:\Driver\WatchDog_AP V3.0.2(Driver V2.0.0.4)\Driver\WMWDG Driver for Win7_64bit

.           [..]           devcon.exe      install.bat      wmwgd.cat        wmwgd.inf        [x64]
4 File(s)          91,617 bytes
3 Dir(s)          60,737,892,352 bytes free

D:\Driver\WatchDog_AP V3.0.2(Driver V2.0.0.4)\Driver\WMWDG Driver for Win7_64bit>install
D:\Driver\WatchDog_AP V3.0.2(Driver V2.0.0.4)\Driver\WMWDG Driver for Win7_64bit>DEVCON.EXE INSTALL wmwgd.inf "root\WMWD
Device node created. Install is complete when drivers are installed...
Updating drivers for root\WMWDG from D:\Driver\WatchDog_AP V3.0.2(Driver V2.0.0.4)\Driver\WMWDG Driver for Win7_64bit\wm
g.inf.
Drivers installed successfully.

D:\Driver\WatchDog_AP V3.0.2(Driver V2.0.0.4)\Driver\WMWDG Driver for Win7_64bit>pause
```

5. Open the Driver CD (included in the package) and select **Watchdog AP**.

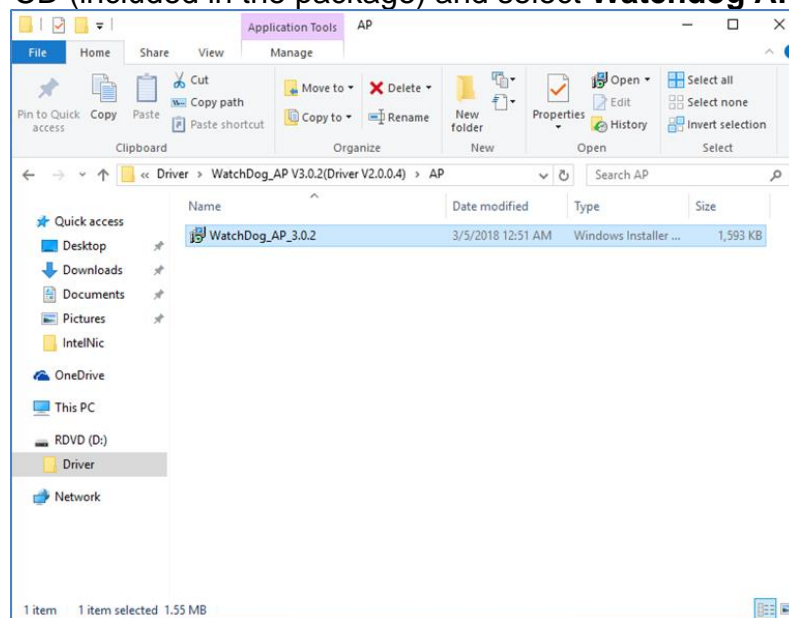

6. Select **Next**.



7. The installed storage location is displayed, select **Next** to continue.

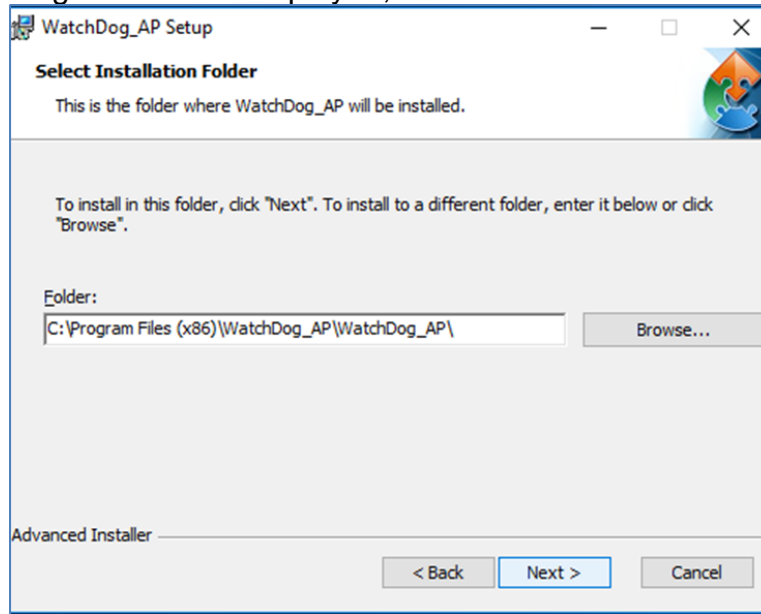

8. Select **Next** to start the installation.

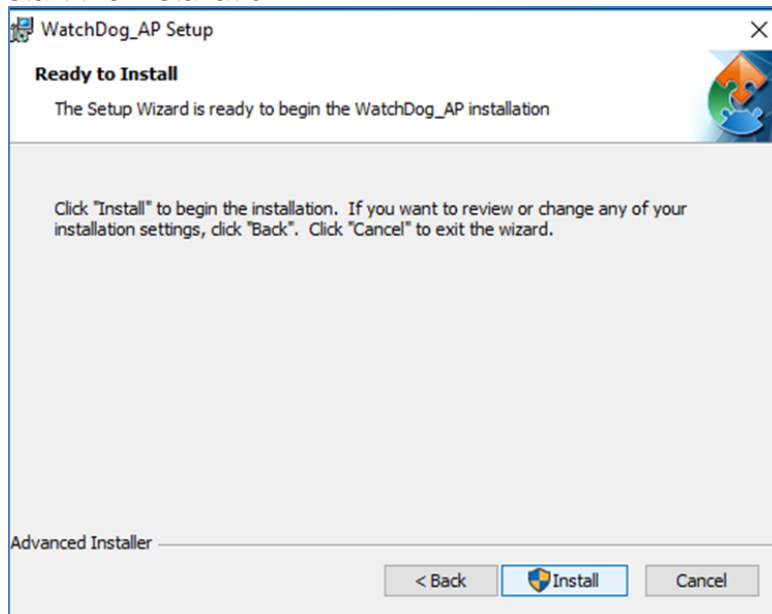

9. When installation is completed, select **Finish** to close the window.

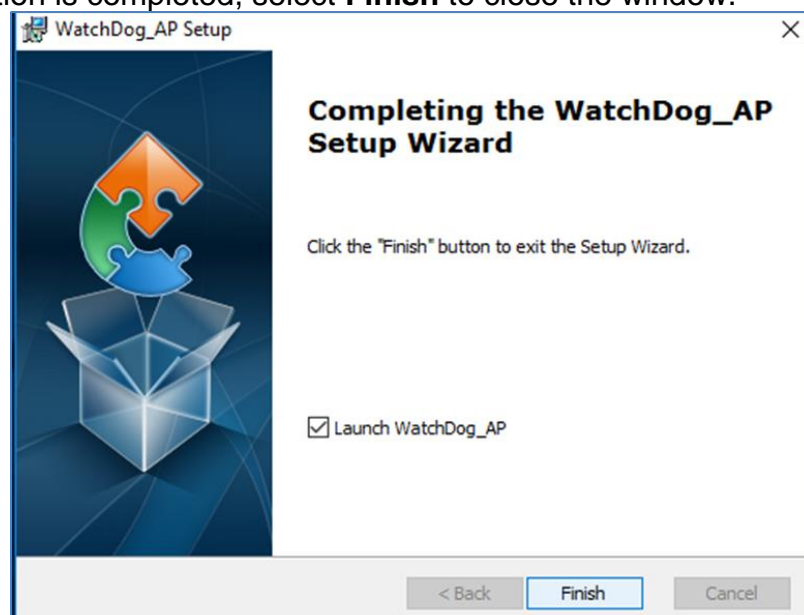

5.7 Digital IO Driver

For more details about Winmate Watchdog, please download Digital IO Guide from Winmate Downloads Center:

Follow instructions below to install **Digital IO** driver.

1. Type “cmd” in the run box then the cmd.exe will appear in programs.
2. Right click on the cmd.exe and click on “Run as administrator” to start.

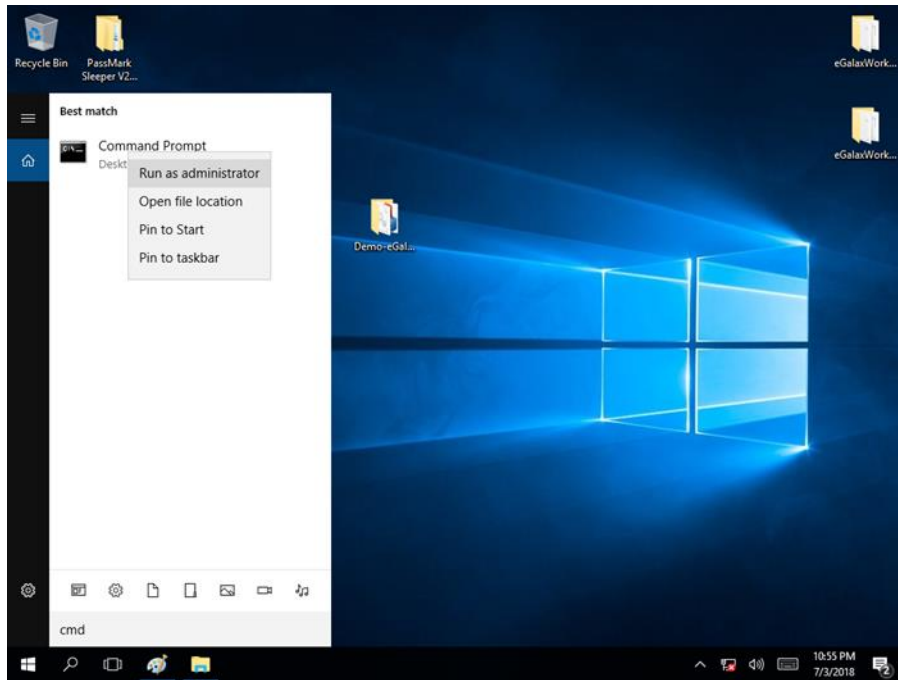

3. Open the Driver CD (included in the package) and select Digital IO driver.
4. When Windows Security dialog appear, select **install** to continue the Installation.
5. Wait for installation to complete. When installation is complete, press any key to close.

```
Administrator: Command Prompt
[.]
WMDIO 64bit Driver Installation Guide v181.pdf      WMDIO Driver for Win7_32bit.zip
WMDIO Driver for Win7_64bit.zip
          3 File(s)      227,270 bytes
          2 Dir(s)      60,734,410,752 bytes free

D:\Driver\WMDIO APP v1.0.0.3\Driver\5.0.6.0>CD WMDIO Driver for Win7_64bit

D:\Driver\WMDIO APP v1.0.0.3\Driver\5.0.6.0\WMDIO Driver for Win7_64bit>DIR/W
Volume in drive D is RDVD
Volume Serial Number is 6834-E6A5

Directory of D:\Driver\WMDIO APP v1.0.0.3\Driver\5.0.6.0\WMDIO Driver for Win7_64bit

[.]          [..]          devcon.exe  install.bat  wmdio.cat   wmdio.inf   [x64]
          4 File(s)          91,614 bytes
          3 Dir(s)          60,736,315,392 bytes free

D:\Driver\WMDIO APP v1.0.0.3\Driver\5.0.6.0\WMDIO Driver for Win7_64bit>INSTALL

D:\Driver\WMDIO APP v1.0.0.3\Driver\5.0.6.0\WMDIO Driver for Win7_64bit>DEVCON.EXE INSTALL wmdio.inf "root\WMDIO"
Device node created. Install is complete when drivers are installed...
Updating drivers for root\WMDIO from D:\Driver\WMDIO APP v1.0.0.3\Driver\5.0.6.0\WMDIO Driver for Win7_64bit\wmdio.inf.
Drivers installed successfully.

D:\Driver\WMDIO APP v1.0.0.3\Driver\5.0.6.0\WMDIO Driver for Win7_64bit>pause
Press any key to continue . . .

D:\Driver\WMDIO APP v1.0.0.3\Driver\5.0.6.0\WMDIO Driver for Win7_64bit>
```

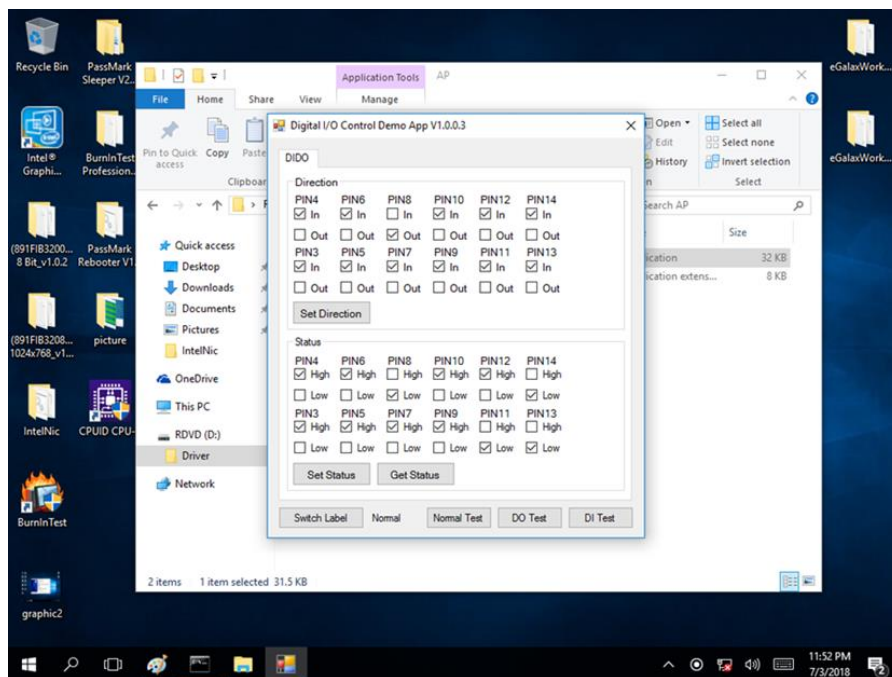
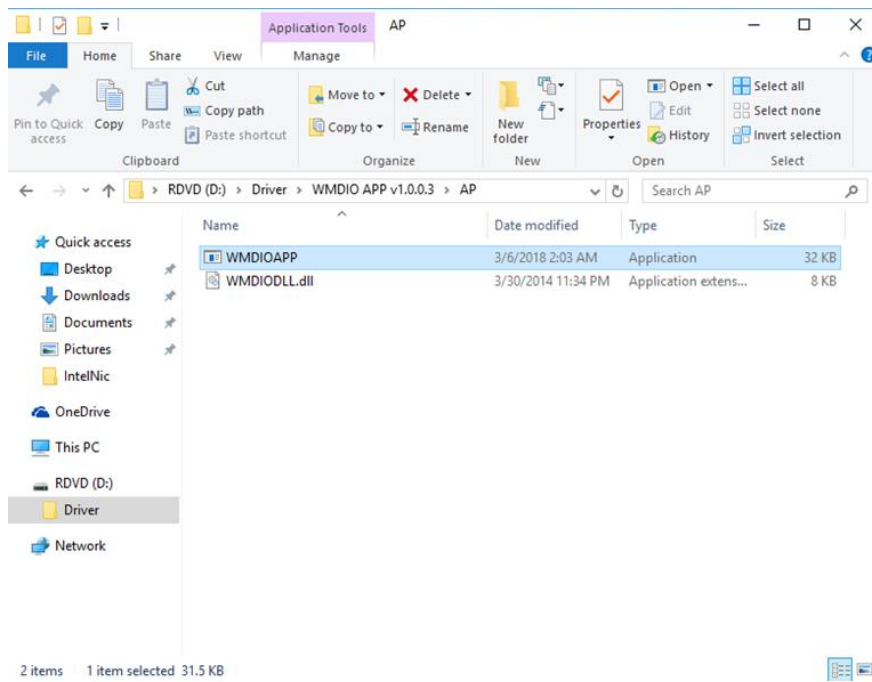
6. Open the Driver CD (included in the package) and select **Digital IO AP**.

Chapter 6: Mounting

This chapter provides mounting guide for all available mounting options. Pay attention to cautions and warning to avoid any damages.



WARNING! / AVERTISSEMENT!

Follow mounting instructions and use recommended mounting hardware to avoid the risk of injury.

Suivez les instructions de montage et d'utilisation recommandé le matériel de montage pour éviter le risque de blessure.

6.1 Cable Mounting Considerations

For a nice look and safe installation, make sure cables are neatly hidden behind the HMI device. Refer to [Chapter 2, section 2.1](#) for the cable installation instruction.



WARNING! / AVERTISSEMENT!

Observe all local installation requirements for connection cable type and protection level.

Suivre tous les règlements locaux d'installations, de câblage et niveaux de protection.



WARNING! / AVERTISSEMENT!

Turn off the device and disconnect other peripherals before installation.

Éteindre l'appareil et débrancher tous les périphériques avant l'installation.



ALTERNATING CURRENT / MISE À LE TERRE!

To prevent electrical shock, the Safety Ground location on the rear must be bonded to the local earth ground through a minimum 12 AWG wire as short as possible

Pour éviter les chocs électriques, l'emplacement de la prise terre à l'arrière doit être lié à terre locale, à travers un 12 AWG minimum et aussi court que possible.

6.2 Safety Precautions

Observe the following common safety precautions before installing any electronic device:

- Use separate, non-intersecting paths to route power and networking wires. If power wiring and device wiring paths must be crossed make sure the wires are perpendicular at the intersection point.
- Keep the wires separated according to the interface. Wires that share similar electrical characteristics must be bundled together.
- Do not bundle input wiring with output wiring. Keep them separate.

When necessary, it is strongly advised that you label wiring to all devices in the system.

6.3 Mounting Guide

The IP65 Stainless R Series Panel PC comes with different mounting options suitable for most of the industrial applications. The main mounting approach is chassis - very user-friendly in terms of installation. Refer to sub-sections below for more details.

6.3.1 VESA Mount

Stainless R Series Panel PC has VESA mount holes on the rear side. Follow instructions below to mount the unit with VESA Mount bracket (not supplied by Winmate).

Size	VESA Plate Dimensions	Screw hole diameter
15", 17", 19"	100 x 100 mm	VESA M4x5 mm
21.5"	100 x 200 mm	VESA M4x5 mm
23.8"	100 x 200 mm	VESA M6x8 mm

Mounting Steps:

1. Screw VESA bracket to the fixture (ex. swing arm) with four VESA screws.
2. Place the device on VESA bracket.



NOTE:

Notice that both hooks on bracket should lock the notches on the back cover of the device.

6.3.2 Yoke Mount

Yoke Mount solution allows installing the Panel PC with the bracket (not supplied by Winmate).

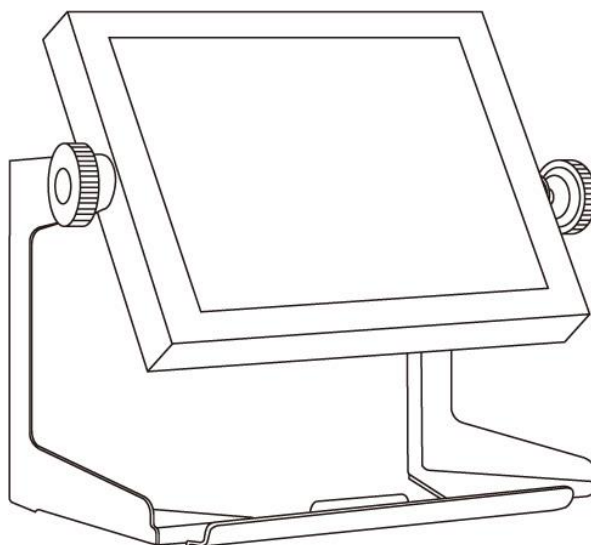

Mounting instruction:

1. Place the Panel PC on the bracket stand, aiming screw holes for each other.
2. Secure screws to fix the device upon the bracket stand.
3. Firmly secure the locking handle to the Panel PC.

Chapter 7: Technical Support

This chapter includes technical support documents and software developing kit (SDK). If any problem occurs fill in [problem report form](#) enclosed and immediately contact us.

7.1 Software Developer Support

Winmate provides the following SDK and Utilities for the IP65 Stainless R Series Panel PC

Item	File Type	Description
1	SDK	Watchdog SDK
2	Utility	Watchdog Utility

To find the Drivers and SDK, please refer to the Driver CD that comes in the package or contact us. Also, you can download drivers from Winmate Download Center.

Go to <https://www.winmate.com/> > Support > Download Center > Stainless Series > IP65 R Series Panel PC

Appendix A: Product Specifications

	Model Name				
	R15IW3S-SPC3-R	R17IW3S-SPM1-R	R19IW3S-SPM1-R	W22IW3S-SPA3-R	W24IW3S-SPA2-R
Display					
Size	15"	17"	19"	21.5"	23.8"
Resolution	1024 x 768	1280 x 1024	1280 x 1024	1920 x 1080	1920 x 1080
Brightness	300 nits	350 nits	250 nits	250 nits	250 nits
Contrast Ratio	2000 : 1	1000 : 1	1000 : 1	3000 : 1(typ.)	3000 : 1
Viewing Angle	88,88,88,88	85,85,80,80	85,85,80,80	89,89,89,89	89,89,89,89
Touch	Projected Capacitive Multi Touch Screen				
System					
Processor	Intel® Core™ i5 -8265U (6M Cache, 1.6GHz up to 3.9 GHz)				
System Memory	1 x SO-DIMM, DDR4 2400 MHz, 4GB (Optional, up to 32 GB)				
Storage	1 x M.2 2242 B-key SSD 64GB (Optional, up to 512GB or M.2 2280 MKey NVME SSD, up to 4TB)				
Ethernet Controller	Intel® Ethernet Controller I210-AT + Intel® Ethernet Connection I219-LM				
Operating System	Windows 10 IoT Enterprise (Optional) Linux Ubuntu 18.04 (Optional)				
Security	Trusted Platform Module (TPM 2.0)				
Input/ Output Connectors					
Ethernet LAN	1 x Waterproof Giga LAN RJ45 Connector				
COM	1 x M12 waterproof connector for RS232				
USB	1x M12 Waterproof Connector for 2 x USB2.0				
Indicator	1 x LED Indicator for power 1 x LED Indicator for storage				
Button	1 x Power Button 1 x Reset Button				
Power	1 x 12V DC (M12 type)				
Mechanical Specification					
Cooling System	Fanless				
Mounting	Yoke Mount, VESA Mount, Arm Mount				
Housing	Stainless steel				
Environmental Consideration					
Operating Temperature	0°C to +45°C				
Operating Humidity	10% to 90% (non-condensing)				
IP Rating	IP65				
Standards and Certification					
Certification	CE, FCC				

Note:

- Accessories and Integrated Options may vary depending on your configuration. The product shown in this document is a standard model. For diagrams that contain customized or optional I/O, please contact the Winmate Sales Team for more information.
- All specifications are subject to change without prior notice.
- For more information about Universal Carrying System Adapter for Winmate Stainless Panel PCs (with Junction Box), please refer to https://www.winmate.com/Support/Mounting_ARMMount

Appendix B: Order Information

IP65 Stainless R Series Panel PC available for ordering in the following configurations.

SBC		Panel PC	
RAM	SODIMM DDR3L Max 8GB	OS	Windows 10 IoT Enterprise Windows Embedded 8.1 Industry Pro Windows Embedded 8 Standard Windows Embedded 7 Standard
Storage	Mini PCIe SSD	Touch	AG Coating

Winmate Inc.
9F, No.111-6, Shing-De Rd., San-Chung District,
New Taipei City 24158, Taiwan, R.O.C
www.winmate.com

